

CLV41x
Bar Code Scanner

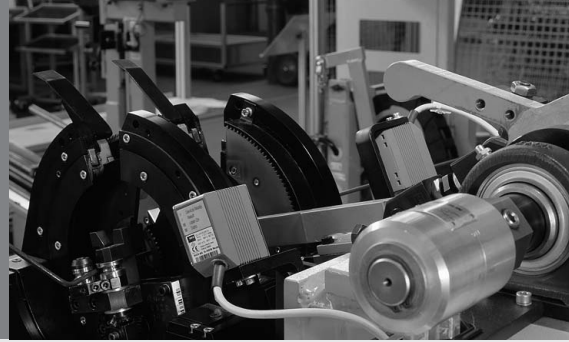

Standard Line



Software versions

Software/Tool	Function	Version
CLV 410	Firmware	V 1.60 0079
CLV 412	Firmware	V 1.60 0079
CLV 410-2010 S02	Firmware	V 1.60 0079
CLV 414	Firmware	V 1.60 0079
CLV Setup	User software (Windows-based)	V 4.10 0508
CLV Setup Help	Online help (HTML)	V 4.10 0508

UL Certification



The CLV 41x is UL certificated when a class 2 power supply according to UL 1310 is used.

Valid only with corresponding product marking on the nameplate.

FCC class

This appliance meets FCC class B, subject to the FCC-regulations, paragraph 15.

Note To meet the FCC-regulations, the cables have to shielded including connections from shielding to the connector casings.

Copyright

Copyright © 2004
 SICK AG Waldkirch
 Auto Ident, Reute Plant
 Nimburger Strasse 11
 79276 Reute
 Germany

Trademarks

Windows 95™/98™, Windows NT™, Windows 2000™, Windows XP™ and Internet Explorer™ are registered trademarks or trademarks of the Microsoft Corporation in the USA and other countries.

Latest manual version

For the latest version of this manual (PDF), see www.sick.com.

CLV 41x bar code scanner**Quick Finder**

- **Scope of delivery**
 - *Chapter 3.1.1 Scope of delivery, Page 3-1*

- **IMPORTANT!**
 - *Chapter 2 Safety information, Page 2-1*

- **Installing device at reading station**
 - *Chapter 4 Installation, Page 4-1*

- **Electrical connection of device**
 - *Chapter 5 Electrical connection, Page 5-1*

- **Overview of device and its functions**
 - *Chapter 3 Product description, Page 3-1*
 - *Chapter 6.2 Default settings, Page 6-1*
 - *Chapter 6.5 Operating modes and outputting the reading result, Page 6-14*
 - *Chapter 9 Technical data, Page 9-1*

- **Starting device with default settings**
 - *Chapter 6.3 Quick start, Page 6-3*

- **Installing "CLV Setup" user software to PC**
 - *Chapter 10.3 Installation and operating instructions for the PC-based "CLV Setup" program, Page 10-5*

- **Adapting device to reading application**
 - *Chapter 6.4 Configuration (parameterizing), Page 6-4*

- **Troubleshooting**
 - *Chapter 8 Troubleshooting, Page 8-1*

- **Finding information**
 - *Table of contents, Page E-5*
 - *Index, Page 10-47*

Installation procedure (overview)

Reading triggering via polling reflector (default setting)

1. Check scope of delivery for completeness.
 2. Install the CLV at the reading station and align the reading window with an object possessing a bar code.
 3. Align the supplied white polling reflector (special code) to the reading window of the CLV with a reading distance of approx. 300 mm (11.82 in) and fix the reflector temporarily at the side of the reading station. Later, the reflector should be in the center of the scan line (white reflector: distance 40 to 500 mm (1.58 to 19.7 in), blue reflector: distance 500 to 800 mm (19.7 to 31.5 in))
 4. Install the CDB 410 or CDM 410 connection module.
 5. Connect the CLV to the CDB 410 or CDM 410 connection module.
 6. Connect the host to the "host interface" in the CDB 410 or CDM 410.
 7. Switch on the power supply to the CDB 410 or CDM 410.
After the CLV has been started, the "Device Ready" LED lights up. The beeper signals that reading mode has been started by means of two consecutive tones.
 8. Switch on PC and start Windows™ (at least Windows 95™ required).
 9. Install accompanying user software "CLV Setup" and online help "CLV Setup Help" from CD ROM ("Manuals & Software") to PC.
 10. Connect the PC to the host interface 2 of the CLV.
For this purpose, connect the PC via a 3-core RS 232 data cable (null modem cable) to the 9-pin "Aux" plug in the CDB 410 or CDM 410.
 11. Start "CLV Setup" user software.
CLV Setup starts the communication with the CLV and copies the parameter set of the CLV via an upload. The parameter set is displayed on tabs.
 12. Start the terminal emulator in CLV Setup.
 13. Carry out a test reading with a bar code pattern in the following sequence:
 - block the polling reflector, e. g. using a sheet of paper
 - present the bar code pattern at a reading distance of approx. 200 mm (7.88 in) (not for CLV 414)
 - unblock the polling reflectorIf the bar code was read successfully, the reading result is displayed in the terminal emulator.
 14. Configure the CLV for the application by means of the setting options on the tabs in CLV Setup.
Copy the modified parameter set temporarily to the CLV via download.
Do not switch off the power supply of the CDB 410 or CDM 410 (of the CLV)!
 15. Run a test under realistic conditions.
 16. Check proper data transfer of the CLV to the host.
 17. Correct and optimize the set parameter values if necessary.
Copy the parameter set to the CLV **permanently** via download.
 18. Save the parameter set as a "*.scl" configuration file in CLV Setup.
- The CLV contains **application-specific** settings and is ready for operation.

Table of Contents

1	Notes on this document.....	1-1
1.1	Function.....	1-1
1.2	Target audience.....	1-1
1.2.1	Installation, electrical connection, maintenance and replacement.....	1-1
1.2.2	Startup, operation and configuration.....	1-1
1.3	Information content.....	1-1
1.4	Symbols used.....	1-2
2	Safety information.....	2-1
2.1	Authorized personnel.....	2-1
2.1.1	Installation and maintenance.....	2-1
2.1.2	Electrical connection and replacement.....	2-1
2.1.3	Startup, operation and configuration.....	2-1
2.2	Intended use.....	2-1
2.3	General safety instructions and protection measures.....	2-2
2.4	Quick stop and quick restart.....	2-4
2.4.1	Switching off the CLV.....	2-4
2.4.2	Restarting the CLV.....	2-4
2.5	Environmental information.....	2-4
2.5.1	Power requirements.....	2-4
2.5.2	Disposal after final decommissioning.....	2-4
3	Product description.....	3-1
3.1	Design.....	3-1
3.1.1	Scope of delivery.....	3-1
3.1.2	Variants.....	3-1
3.1.3	System requirements.....	3-2
3.1.4	Product features and functions (overview).....	3-3
3.1.5	View of line/raster scanner devices.....	3-5
3.2	Method of operation.....	3-6
3.2.1	Scan procedure variants.....	3-7
3.3	Indicators and operating elements.....	3-7
3.3.1	Operating elements.....	3-7
3.3.2	Function of the LED indicators.....	3-7
3.3.3	Function of the beeper.....	3-8
4	Installation.....	4-1
4.1	Overview of installation sequence.....	4-1
4.2	Installation preparations.....	4-1
4.2.1	Laying out required components to be installed.....	4-1
4.2.2	Laying out accessories.....	4-1
4.2.3	Laying out other required materials.....	4-1
4.2.4	Replacing the laser warning label.....	4-2
4.2.5	Selecting the installation location.....	4-2
4.2.6	Mounting accessories.....	4-2
4.2.7	Distance between the CLV and the bar code.....	4-4
4.2.8	Count direction of the code position CP.....	4-6
4.3	Installing and adjusting the device.....	4-7
4.3.1	Installing the CLV.....	4-7
4.3.2	Adjusting the CLV.....	4-7
4.4	Installing external components.....	4-8
4.4.1	Installing the CDB 410 or CDM 410 connection module.....	4-8
4.4.2	Installing the polling reflector.....	4-8
4.4.3	Alternative: Installing the external reading pulse sensor.....	4-10
4.5	Removing the device.....	4-11
5	Electrical connection.....	5-1
5.1	Overview of the connection sequence.....	5-1

5.2	Electrical connections and cables	5-1
5.2.1	Connections/cables for the CDB 410 or CDM 410 connection module	5-1
5.3	Connector pin assignment.....	5-2
5.4	Preparations for electrical connection.....	5-3
5.4.1	Requirements for the host interface	5-3
5.4.2	Power supply	5-3
5.4.3	Non-SICK power pack/connections without the SICK connection module	5-4
5.5	Making electrical connections	5-4
5.5.1	Overview of connection procedure.....	5-4
5.5.2	Auxiliaries	5-4
5.5.3	Connecting the power supply	5-5
5.5.4	Connecting the host interface	5-5
5.5.5	Connecting the PC to the host interface 2 (RS 232)	5-7
5.5.6	Connecting the "Sensor 1" switching input.....	5-10
5.5.7	Connecting the "Sensor 2" switching input.....	5-11
5.5.8	Connecting the "Result 1" to "Result 3" switching outputs	5-12
6	Operation	6-1
6.1	Overview of procedure for starting up the CLV.....	6-1
6.2	Default settings	6-1
6.2.1	Default settings: line/raster scanner CLV 41x	6-2
6.3	Quick start.....	6-3
6.3.1	Starting up the line/raster scanner with the factory default settings	6-3
6.4	Configuration (parameterizing)	6-4
6.4.1	Configuring CLV with the user interface of CLV Setup	6-4
6.4.2	Function of tabs in CLV Setup (overview)	6-5
6.4.3	Parameterization guide.....	6-7
6.4.4	Configuring the CLV with AutoSetup.....	6-11
6.5	Operating modes and outputting the reading result.....	6-14
6.5.1	Reading mode (standard operating mode)	6-14
6.5.2	Percentage evaluation.....	6-17
6.5.3	Read Rate Evaluation.....	6-19
6.5.4	Displaying and editing operating data	6-20
6.5.5	Self-test	6-20
6.5.6	Performing device functions of the CLV in the dialog box	6-21
6.6	CLV messages.....	6-22
6.7	Switching off the CLV	6-22
7	Maintenance.....	7-1
7.1	Cleaning during operation	7-1
7.2	Maintenance	7-2
7.3	Disposal	7-2
8	Troubleshooting.....	8-1
8.1	Overview of errors and malfunctions which could occur	8-1
8.1.1	Installation errors.....	8-1
8.1.2	Electrical connection errors	8-1
8.1.3	Parameterization errors.....	8-1
8.1.4	Malfunctions during operation.....	8-1
8.2	Monitoring errors and malfunctions	8-1
8.3	Error messages.....	8-2
8.4	Troubleshooting	8-3
8.4.1	General malfunction: CLV not ready.....	8-3
8.4.2	Malfunctions in reading mode: reading pulse errors	8-4
8.4.3	Malfunctions in reading mode: result output errors.....	8-5
8.4.4	Malfunctions in reading mode: errors when outputting the result status.....	8-7
8.4.5	Malfunctions: configuration errors (parameterization)	8-7
8.5	SICK Support.....	8-8
9	Technical data	9-1
9.1	Data sheet CLV 41x bar code scanner (fixed focus)	9-1

9.2	CLV dimensional drawings.....	9-3
10	Appendix	10-1
10.1	Overview.....	10-1
10.2	Specification diagrams.....	10-1
10.2.1	Reading conditions for all diagrams.....	10-1
10.2.2	Reading field diagram for CLV 410 line/raster scanner (standard)	10-2
10.2.3	Reading field diagram for CLV 412 line/raster scanner (high density)	10-3
10.2.4	Reading field diagram for CLV 410-2010 S02 line scanner (side reading window)	10-4
10.2.5	Reading field diagram CLV 414 line scanner (short range)	10-4
10.3	Installation and operating instructions for the PC-based "CLV Setup" program.....	10-5
10.3.1	Preparations for installation.....	10-5
10.3.2	Installation.....	10-5
10.3.3	Starting "CLV Setup".....	10-8
10.3.4	CLV Setup graphical user interface.....	10-11
10.3.5	Functions.....	10-12
10.3.6	Hot keys.....	10-12
10.3.7	Opening and closing tabs.....	10-13
10.3.8	Online help – CLV Setup Help.....	10-13
10.3.9	Transferring parameter sets between CLV Setup and the CLV	10-14
10.3.10	Dealing with unknown parameters.....	10-14
10.3.11	Writing a log file in terminal emulator	10-14
10.3.12	Starting CLV Setup with an INI file as an argument.....	10-15
10.3.13	CLV Assistant.....	10-15
10.4	Configuring the CLV with profile bar codes	10-16
10.4.1	Activating AutoSetup with a profile bar code.....	10-16
10.4.2	Profile programming.....	10-18
10.5	Configuring the CLV with command strings	10-22
10.6	Calculating parameter values for setting the CLV	10-24
10.6.1	Calculating the number of scans.....	10-24
10.7	Tables.....	10-25
10.7.1	Calculating code length of a bar code	10-25
10.8	Special applications and procedures.....	10-26
10.8.1	Triggering the teach-in match code 1 via the "Sensor 2" switching input.....	10-26
10.8.2	Structure of a daisy chain configuration (data forwarding or master/slave arrangement)	10-32
10.8.3	Structure of a SICK network (RS 485)	10-32
10.8.4	Connection to Profibus DP.....	10-32
10.8.5	Connection to DeviceNet.....	10-32
10.8.6	Connection to Interbus S	10-32
10.8.7	Connection to Ethernet.....	10-32
10.9	Replacing a CLV (copying the parameter set)	10-33
10.9.1	Transferring the parameter set using the profile bar codes	10-33
10.9.2	Downloading the parameter set.....	10-34
10.10	Accessories.....	10-36
10.10.1	Installation accessories	10-36
10.10.2	Connection modules.....	10-36
10.10.3	Bus connection modules	10-36
10.10.4	Programming adapter	10-37
10.10.5	Cables and plug-in connections.....	10-37
10.10.6	Reading pulse generators.....	10-38
10.10.7	Network controller	10-38
10.11	Dimensional drawings of the accessories.....	10-38
10.11.1	Mounting bracket.....	10-38

10.12	Supplementary documentation	10-39
10.12.1	CLV Connect (from Version 1.9).....	10-39
10.13	Glossary	10-40
10.14	EC Declaration of Conformity.....	10-46
10.15	Index.....	10-47
10.16	Bar code samples.....	11-50

Abbreviations

BMV/S	B usanschluss m odul mit V erteiler (Signal)/mit zusätzlicher S tromversorgung. Bus connection modul with distributor (signal)/with additional power supply
CDB	C onnection D evice B asic
CDM	C onnection D evice M odular
CLV	C ode- L eser V -Prinzip – Code reader V principle.
DOF	D ept H O f F ield
EEPROM	E lectrically E rasable P rogrammable R ead O nly M emory
HD	H igh- D ensity (referred to module width)
HTML	H yper T ext M arkup L anguage
LED	L ight E mitting D iode
PLC	P rogrammable L ogic C ontroller
RAM	R andom A cces M emory
ROM	R ead O nly M emory
RTF	R ich T ext F ormat

Tables

Table 3-1:	Variants of the CLV 41x.....	3-1
Table 3-2:	Meaning of the LED indicators.....	3-8
Table 3-3:	Beeper function.....	3-9
Table 4-1:	Permissible reading angles between the scan line and bar code	4-5
Table 4-2:	Permissible range values for the polling reflectors	4-9
Table 5-1:	Pin assignment of the 15-pin D Sub HD plug.....	5-2
Table 5-2:	Maximum cable lengths between the CLV and host.....	5-3
Table 5-3:	Power-up delay as a function of the device number GN.....	5-3
Table 5-4:	Wiring color assignment of cable no. 6 010 137 (open end).....	5-4
Table 5-5:	Communication parameters for the host interfaces (default setting)	5-6
Table 5-6:	Characteristic data of the "Sensor 1" switching input.....	5-10
Table 5-7:	Reduced debouncing of the "Sensor 1" switching input.....	5-11
Table 5-8:	Characteristic data of the "Result 1" to "Result 3" switching outputs	5-12
Table 6-1:	Extract: Default parameter settings of the line/raster scanner CLV 41x.....	6-2
Table 6-2:	Reading distances for module width 0.5 mm (19.7 mil), default settings....	6-3
Table 6-3:	Guide: parameterizing reading pulse source and read result output time ...	6-7
Table 6-4:	Guide: parameterizing laser timeout	6-9
Table 6-5:	Guide: settings to be made for the evaluation of identical bar codes	6-9
Table 6-6:	Read Rate Evaluation: Tone sequence of the beeper as a function of the reading rate	6-19
Table 8-1:	Meaning of the ST error status in the reading result	8-2
Table 8-2:	Troubleshooting: restoring operation (reading mode)	8-3
Table 8-3:	Troubleshooting: reading pulse errors in reading mode.....	8-4
Table 8-4:	Troubleshooting: result output errors in reading mode.....	8-5
Table 8-5:	Troubleshooting: errors in the result status output in reading mode	8-7
Table 8-6:	Troubleshooting: configuration errors (parameterization)	8-7
Table 9-1:	Technical specifications of the CLV 41x (line/raster scanner).....	9-1
Table 10-1:	Reading conditions for specification diagrams.....	10-1
Table 10-2:	Default settings of CLV Setup (extract).....	10-8
Table 10-3:	Functions of preprinted profile bar codes on card no. 8 008 085.....	10-20
Table 10-4:	Formulas for calculating the code length of a bar code	10-25
Table 10-5:	Accessories: installation accessories.....	10-36
Table 10-6:	Accessories: Connection modules.....	10-36
Table 10-7:	Accessories: bus connection modules.....	10-36

Table 10-8: Accessories: Programming adapter.....	10-37
Table 10-9: Accessories: cables and plug-in connections	10-37
Table 10-10: Accessories: reading pulse generators (polling reflectors)	10-38
Table 10-11: Accessories: Network controller.....	10-38
Table 10-12: Supplementary documentation (English versions)	10-39

Figures

Fig. 2-1:	Laser warning labels found on the CLV.....	2-3
Fig. 3-1:	CLV 41x line/raster scanner with/without 105° angle attachment.....	3-5
Fig. 3-2:	Block diagram: CLV functions.....	3-6
Fig. 3-3:	LED indicators	3-7
Fig. 4-1:	Example line scanner: replacing the laser warning label	4-2
Fig. 4-2:	Location of the securing threads on the CLV.....	4-3
Fig. 4-3:	Installation example: mounting the CLV with mounting bracket no. 2 020 077	4-3
Fig. 4-4:	Scanning methods: alignment with bar code and conveyor direction.....	4-4
Fig. 4-5:	Definition of the reading distance a and the aperture angle α	4-4
Fig. 4-6:	Line scanner: reading angles between the scan line and the bar code.....	4-5
Fig. 4-7:	Preventing surface reflection: angle between the emitted light and bar code (tilted away from the vertical axis)	4-5
Fig. 4-8:	Count direction of the code position CP within the scan line.....	4-6
Fig. 4-9:	Line scanner: installation location of the polling reflector	4-9
Fig. 4-10:	Line scanner: installation example for the external reading pulse sensor	4-10
Fig. 5-1:	Block diagram: connection of the CLV to the CDB 410 or CDM 410 connection module.....	5-1
Fig. 5-2:	Connections of the host interface	5-5
Fig. 5-3:	Design of the programming adapter no. 7 034 552.....	5-8
Fig. 5-4:	Connection of the host interface 2 (RS 232) via the programming adapter no. 7 034 552	5-9
Fig. 5-5:	Connections of the "Sensor 1" switching input.....	5-10
Fig. 5-6:	Connections of the "Sensor 2" switching input.....	5-11
Fig. 5-7:	Connections of the "Result 1" switching output	5-12
Fig. 6-1:	Bar code pattern (code 39; module width 0.5 mm (19.7 mil); print ratio 2:1)	6-3
Fig. 6-2:	CLV Setup: Reading mode: output of the reading result in the terminal emulator.....	6-15
Fig. 6-3:	CLV Setup: Percentage evaluation mode: output of the reading result in the terminal emulator.....	6-17
Fig. 6-4:	Percentage evaluation mode: structure of the reading result for "good read"	6-18
Fig. 6-5:	Percentage evaluation mode: structure of the reading result for "no read"	6-18
Fig. 6-6:	CLV Setup: Calling up the "Read Rate Evaluation" mode in the terminal emulator.....	6-19
Fig. 6-7:	CLV Setup: "Operating Data" dialog box.....	6-20
Fig. 6-8:	CLV Setup: displaying the self-test result in the terminal emulator.....	6-21
Fig. 6-9:	CLV Setup: dialog box for AutoSetup execution	6-22
Fig. 7-1:	Cleaning the reading window.....	7-1
Fig. 7-2:	Cleaning the external optical sensor (reading pulse generator).....	7-2
Fig. 9-1:	Dimensions of the CLV 41x line/raster scanner.....	9-3
Fig. 10-1:	CLV 410-0010/1010: reading range (DOF) and scanning frequency characteristic for line/raster scanner (standard).....	10-2
Fig. 10-2:	CLV 412-0010/1010: reading range (DOF) and scanning frequency characteristic for line/raster scanner (high density).....	10-3
Fig. 10-3:	CLV 410-2010 S02: reading range (DOF) for line scanner.....	10-4
Fig. 10-4:	CLV 414-0010: reading range (DOF) for line scanner (short range)	10-4
Fig. 10-5:	CLV Setup: AutoBaud-Detect: Message about temporarily resetting the communication parameters in the CLV 41x.....	10-9
Fig. 10-6:	CLV Setup: results of the AutoBaud detect function.....	10-9
Fig. 10-7:	CLV Setup: Restoring the previous communication parameters	10-10
Fig. 10-8:	User interface of the "CLV Setup" software.....	10-11
Fig. 10-9:	CLV Setup: entering commands in the terminal emulator	10-23

Fig. 10-10:	Line scanner: calculating the number of scans for ladder-type bar code arrangements	10-24
Fig. 10-11:	Line scanner: calculating the number of scans for fence-type bar code arrangements	10-24
Fig. 10-12:	"Sensor 2" configuration for triggering the teach-in match code 1.....	10-26
Fig. 10-13:	Dimensions of the mounting bracket no. 2 020 077	10-38
Fig. 10-14:	Dimensions of the mounting bracket no. 2 020 078.....	10-38
Fig. 10-15:	Copy of the Declaration of Conformity, Page 1 (scaled down).....	10-46
Fig. 10-16:	Scannable bar codes with various module widths (print ratio 2:1)	11-50

1 Notes on this document

1.1 Function

This document contains instructions for operating the following bar code scanners:

- CLV 410 with fixed focus, standard range
- CLV 412 with fixed focus, high density
- CLV 414 with fixed focus, short range

in the variants

- Line scanner without/with 105° angle attachment
- Raster scanner without/with 105° angle attachment.

This document provides information on

- Installation and electrical connection
- Startup
- Operation and configuration (parameterizing)
- Maintenance
- Replacing the device while retaining the parameter set
- Special applications and procedures.

The bar code scanners will all simply be called "CLV" below, except in such text passages where a differentiation is required.

1.2 Target audience

This document is intended for persons who are responsible for the following activities:

1.2.1 Installation, electrical connection, maintenance and replacement

Electricians and service technicians

1.2.2 Startup, operation and configuration

Technicians and engineers

1.3 Information content

This document contains all of the information required to install, make electrical connections and start up the CLV with the **factory default settings**.

A series of step-by-step instructions is provided for each of these activities.

The CLV is configured for **specific applications** using the Windows-based "CLV Setup" and "CLV Assistant". Further assistance is also available in the form of the online help system "CLV Setup Help". The procedure for installing and operating the user interface of the software is described in the Appendix.

For further information on the design of the bar code scanner or on bar code technology in general, please contact the Auto Ident division at SICK AG.

Internet address: **www.sick.com**.

1.4 Symbols used

Some of the information in this document is marked specially so that you can access it quickly:



Warning

Warnings are provided to prevent injury to operating personnel or serious damage to the bar code scanner.

- Always read warnings carefully and observe them at all times.

Note Notes indicate special features or characteristics.

Explanation Explanations provide background information on technical correlations.

Recommendation Recommendations help you carry out certain procedures more effectively.

Tip Tips explain settings in the user interface of the CLV Setup program.

Default setting Marks a section containing the values of the factory default settings.

SCANNING FREQUENCY This font indicates a term in the user interface of the CLV Setup program.



Icons refer to buttons in the user interface of the CLV Setup program.



This symbol identifies sections that describe steps carried out with the user interface of the CLV Setup program.



This symbol is used to mark sections that describe steps carried out with the profile programming.



This symbol refers to additional technical documentation.

- An action must be performed. This symbol identifies single-step instructions. Instructions consisting of several steps are numbered consecutively.
- ⇒ Here you select a function of the user interface of CLV Setup.

2 Safety information

2.1 Authorized personnel

For the CLV to function correctly and safely, it must be installed and operated by sufficiently qualified personnel.

The end user must be supplied with the operating instructions.

The end user must be provided with expert tuition and is advised to read the operating instructions.

The following qualifications are required for the various tasks involved:

2.1.1 Installation and maintenance

- Practical basic technical training
- Knowledge of the standard guidelines relating to safety in the workplace

2.1.2 Electrical connection and replacement

- Practical training in electrical engineering
- Knowledge of the standard safety guidelines relating to electrical engineering
- Knowledge regarding the operation of the devices in the relevant application (e.g. conveyor belt)

2.1.3 Startup, operation and configuration

- Knowledge regarding the operation of the devices in the relevant application (e.g. conveyor belt)
- Knowledge of the software and hardware environment of the relevant application (e.g. conveyor belt)
- Basic understanding of Windows 95™/98™, Windows NT4.0™, Windows 2000™ or Windows XP™
- Basic understanding of an HTML browser (e.g. Internet Explorer™)
- Basic understanding of data transfer methods
- Basic understanding of bar code technology

2.2 Intended use

The CLV is designed to detect and decode bar codes automatically. It is installed in a reading station and reads bar codes on objects positioned on a conveyor belt, for example.

The CLV transfers the data content of the decoded bar codes via its host interface to a host for further processing.

Any warranty claims vis-à-vis SICK AG will be rendered invalid if the device is used for any other purpose or if changes are made to the device, including any made during the installation and electrical connection procedures.

Note Don't open the device. The producer warranty will be forfeited if the device is opened.

2.3 General safety instructions and protection measures

- Carefully read the general safety instructions and observe them at all times. This also applies to the warnings provided for the activities described in each chapter of this document.



Risk of injury by electrical current

In the CDM 410 Connection Module, the optional CMP 400 Power Supply Module is connected to a mains voltage of 100 to 250 V AC/ 50 Hz to 60 Hz.

- When working with electrical equipment, always follow the relevant safety regulations.



Laser radiation can seriously damage your eyesight.

The CLV uses a class 2 red-light laser. Looking directly at the laser beam can seriously damage the retina in your eyes.

The entire glass window acts as a laser outlet aperture.

Caution – use of controls or adjustments or performance of procedures other than those specified herein may result in hazardous radiation exposure.

- As with sunlight, never look directly into the laser beam.
- Do not direct the laser beam at other persons.
- Mount and align the CLV in such a way to prevent the laser beam reflecting off mirrored surfaces.
- Do not open the housing.
(Opening the housing does not deactivate the laser diode).
- Observe the laser protection specifications (latest version).

Laser power

The laser operates at a wavelength of $\lambda = 670 \text{ nm}$ (visible red light). The power output of the laser beam at the reading window is max. 1.2 mW. The emitted beam is not dangerous to human skin.

The product is classified in laser class 2 (laser class II) in accordance with EN 60825-1, IEC 60825-1, and 21 CFR 1040.10 (for publication date, see the warning sign on the device).

Laser warnings

The laser warning labels (*Fig. 2-1*) are attached at the following positions on the CLV:

- The laser warning symbol and the laser warning in GB English/US English on line/raster scanners are positioned beside the reading window on the wide side of the device (*Fig. 3-1, Page 3-5*). The additional laser warnings in English applicable to the USA are positioned beside the reading window on the front side of the device and at the back end on the wide side.
- The laser warning symbol and the laser warning in GB English/US English on line/raster scanners with a 105° angle attachment are positioned beside the reading window on the wide side (*Fig. 3-1, Page 3-5*). The additional laser warnings in English applicable to the USA are positioned on the back side of the attachment of the device and at the back end on the wide side.

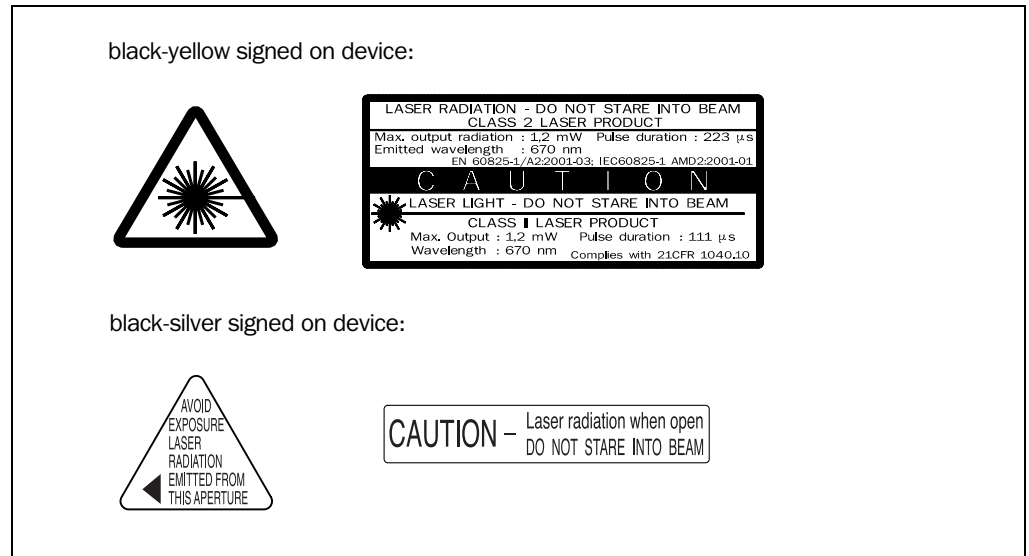

Fig. 2-1: Laser warning labels found on the CLV

Note The device is supplied with an additional set of laser warning labels in German/US English and in French/US English. If necessary, these can be used to cover the GB English/US English warning.

If the CLV is installed in a machine/panel with the result that the laser warning labels are no longer visible, additional warnings (not included in the scope of delivery) must be provided on the machine beside the emergence aperture of the laser beam.

Internal protective circuits

Explanation The CLV is equipped with monitoring circuit-breakers that switch off the laser diode if problems arise with the laser beam. No maintenance required to keep this product in compliance with laser class II.

Activation and deactivation of the laser diode when reading is controlled by the reading pulse (trigger source).

A timer (laser timeout) automatically deactivates the laser diode 10 minutes (default setting) after a continuous reading pulse is initiated in reading mode with switching input pulse modes "Sensor Input" and "Serial Interface". In this case, the CLV outputs three consecutive tones via the beeper.

The reading pulse interval is to be terminated by resetting the pulse signal. The laser diode is activated again by the next reading pulse.

The laser timeout can be set in the range of 1 min to 25 h or deactivated (see *Table 6-4, Page 6-9*).

In the "Percentage Evaluation" mode and "AutoSetup" mode as well as in the pulse modes "Free Running" and "Continuous Read", in reading mode, the laser diode is constantly activated. In the "reflector polling" trigger mode the laser diode is switched on for each 20th scan.

2.4 Quick stop and quick restart

2.4.1 Switching off the CLV

- Switch off the power supply or remove the CLV connector from the connection module.

This can result in loss of the following (at the most):

- the application-specific parameter set, if it was only stored **temporarily** in the CLV
- the last reading result
- daily operating data
(operating hours counter, trigger count, good read count)

2.4.2 Restarting the CLV

- Switch on the supply voltage or reattach the CLV connector to the connection module. The CLV resumes operation with the parameter set that was **last stored permanently** and resets the daily operating data.

2.5 Environmental information

The CLV is designed to cause minimum impact on the environment. It does not contain any silicone-based materials on the housing surface and, therefore, does not represent any problems for e.g. paint sprayers in paint shops.

2.5.1 Power requirements

The power requirements are particularly low:

- the CLV 410/412/414 scanners have a max. power consumption of 3 W

The value is given for devices with disconnected switching outputs.

2.5.2 Disposal after final decommissioning

Always dispose of unusable or irreparable devices in a manner that is not harmful to the environment and in accordance with the applicable national waste disposal regulations. The CLV can be separated into recyclable secondary raw materials and special-category waste (electronic scrap). See *Chapter 7.3 Disposal, Page 7-2*.

At present, SICK AG does not accept any unusable or irreparable devices.

3 Product description

3.1 Design

3.1.1 Scope of delivery

In the **packaging** the CLV is supplied with the following:

- two polling reflectors for automatic reading pulse generation
- an information sheet (note on device) with terminal diagram and Quick Start instructions
- an additional set of Class 2 laser warning labels (self-adhesive) in German/US English and French/US English

Depending on the **number of devices ordered**, one or more copies of the following:

- CD ROM (no. 2 029 112) with
 - "CLV Setup" program for Windows™ and the "CLV Setup Help" online help system (HTML files)
 - "CLV Connect" PC software (HTML files showing terminal diagrams)
 - CLV 41x Operating Instructions in English and German as PDF edition as well as additional publications (connections module, other SICK bar code scanners)
 - freely available "Acrobat Reader" PC software for reading PDF files

Note The latest versions of all the current publications/programs on the CD ROM can also be downloaded from **www.sick.com**.

Depending on the number of **copies ordered**, the delivery includes (**optional**):

- CLV 41x Operating Instructions in English and/or German (printed edition)
- fold-out card with 12 printed profile bar codes

Chapter 10.10 Accessories, Page 10-36 provides an overview of the available installation accessories, connection modules, cables and plug-in connections and sensors for reading pulse generation.

3.1.2 Variants

The CLV is available in the following variants:

CLV 410 (Standard), CLV 412 (High Density), CLV 414 (Short Range)

	Type	Order no.	Scan procedure
Standard	CLV 410-0010	1 015 421	Line scanner
	CLV 410-1010	1 015 427	Raster scanner
	CLV 410-2010	1 017 534	Line scanner with 105° angle attachment
	CLV 410-3010	1 017 536	Raster scanner with 105° angle attachment
High Density	CLV 412-0010	1 017 527	Line scanner
	CLV 412-1010	1 017 528	Raster scanner
	CLV 412-2010	1 017 538	Line scanner with 105° angle attachment
	CLV 412-3010	1 017 540	Raster scanner with 105° angle attachment

Table 3-1: Variants of the CLV 41x

	Type	Order no.	Scan procedure
Short Range	CLV 414-0010	1 017 368	Line scanner
	CLV 414-1010	1 017 767	Raster scanner
	CLV 414-2010	1 017 396	Line scanner with 105° angle attachment
	CLV 414-3010	1 017 831	Raster scanner with 105° angle attachment

Table 3-1: Variants of the CLV 41x (contd.)

3.1.3 System requirements

The following are required to start up and operate the CLV:

1. A SICK connection module to provide the power supply and connect the data and function interfaces. Available types:
 - CDB 410-001 (no. 1 023 813) for 6 to 30 V DC, enclosure rating max. IP 65
 - CDM 410-0001 (no. 1 025 361) for 6 to 30 V DC, enclosure rating max. IP 65

– or –

Alternatively, a non-SICK power supply unit with a voltage output of 5 to 30 V DC (functional extra-low voltage pursuant to IEC 364-4-41) and at least **3 W** power output. Cable no. 6 010 137 with 15-pin D Sub HD connector and one open end for connecting the CLV to the external power pack.

Note The CLV 41x is UL certificated when a class 2 power supply according to UL 1310 is used.

2. The following operating voltages/power outputs
 - CDB 410-001: 6 to 30 V DC, in accordance with IEC 364-4-41, at least 3 W
 - CDM 410-0001: 6 to 30 V DC, in accordance with IEC 364-4-41, at least 3 W
 - If the following modules are additionally built-in in the **CDM 410** module:
CMP 400 Power Supply Module: 100 to 250 V AC/50 to 60 Hz
3. With external clock pulse (start/stop of reading interval) supply via the “Sensor 1“ switching input: a suitable reading pulse sensor for signaling the presence of an object with a bar code, e.g. a photoelectric reflex switch.
4. A higher-level computer (host) with a data interface of type RS 422/485 or RS 232.
5. A PC (at least 80486, 66 MHz, 16 MB RAM, CD ROM drive, serial interface, mouse (recommended) with Windows 95™/98™, Windows NT4.0™, Windows 2000™ or Windows XP™).
6. A 3-core RS 232 data cable (null modem cable) with two 9-pin D Sub sockets for connecting the PC to the host interface 2 of the CLV in the connection module CDB 410 or CDM 410, e.g. no. 2 014 054. Pin 2 (RxD) and Pin 3 (TxD) are crossed.
7. Optional the programming adapter no. 7 034 552 to insert the PC in the connection line between CLV 41x and the connection module. Additionally the extension cable no. 6 010 075 is required for connecting the adapter to the connection module as well as a 3-core RS 232 data cable (null modem cable), e. g. no. 2 014 054, to connect the PC to the programming adapter.
8. To use the online help system CLV Setup Help, an HTML browser is required, e.g. Internet Explorer™.
9. For connection of the CLV to the Interbus S, the Profibus DP, the DeviceNet or the Ethernet: the corresponding BMV/BMH 10 bus connection module (on request).

3.1.4 Product features and functions (overview)

High-performance laser scanner

- Fixed focus
- Line scanner, variant: raster scanner
- Front reading window, variant: side reading window
- Reading range 50 to 380 mm (1.97 to 14.97 in), (CLV 410, standard device)
- Resolution 0.2 to 1.0 mm (7.8 to 39.4 mil), (CLV 410, standard device)
- Scanning/decoding frequency 200 to 800 Hz
- Variable active evaluation range of the scan line

Safety and user-friendly features

- Robust, compact metal housing, max. IP 65, CE certification
- UL certificated when a class 2 power supply according to UL 1310 is used (valid only with corresponding product marking on the nameplate).
- Laser class 2, laser diode switches off if reading interval is active for too long and if the output power is exceeded
- Automatic self-test on startup. Can also be triggered at any time
- Diagnosis tools for installing and monitoring the system
- Parameterized output of reading diagnosis data in the read result
- Operating data query, and error status output
- Test string function for signaling readiness for operation
- Low power consumption, other voltage range

Easy operation/configuration

- With "CLV-Setup" PC software for Windows (online), integrated Assistant and Help system
- With Profile bar codes (offline)
- Alternatively with simple command strings, also for use with special devices
- AutoSetup of the reading configuration for simple applications
- Four status LEDs
- Beeper to confirm device functions or operating steps (can be switches off)

Operating modes

- Reading mode
- Percentage evaluation - for assessing the quality of the reads
- AutoSetup

Bar code evaluation

- All standard bar code types
- Max. 10 codes per reading pulse (max. 100 characters), max. 3 per scan
- Separation of identical bar codes of the same code type
- Code comparison (max. 2 match codes), can also be used as filter for the reading result
- Sort sequences: code position, FIFO, LIFO, code length list
- Manipulation of the data output string via filter or format mask

Reading pulse

- External reading pulse, via switching input or serial interface
- Free running with timeout
- Reflector Polling for generating the reading gate automatically
- Continuous Read, only for one bar code per reading interval

Electrical interfaces

- 2 serial host interfaces (RS 422/485 and RS 232) for data output/parameterizing, with variable transfer rate and telegram structure
- 2 switching inputs for external reading pulse and special function (teach-in of match code)
- 3 switching outputs for signaling defined events in reading mode

Connections

- All interfaces are connected via a cable with one 15-pin D Sub HD plug
- CDB 410 or CDM 410 connection module for connection to host (stand-alone), for integration in SICK network (RS 485) or building up a master/slave configuration
- BMS 10/BMV 10 bus connection modules for connection to field bus systems

3.1.5 View of line/raster scanner devices

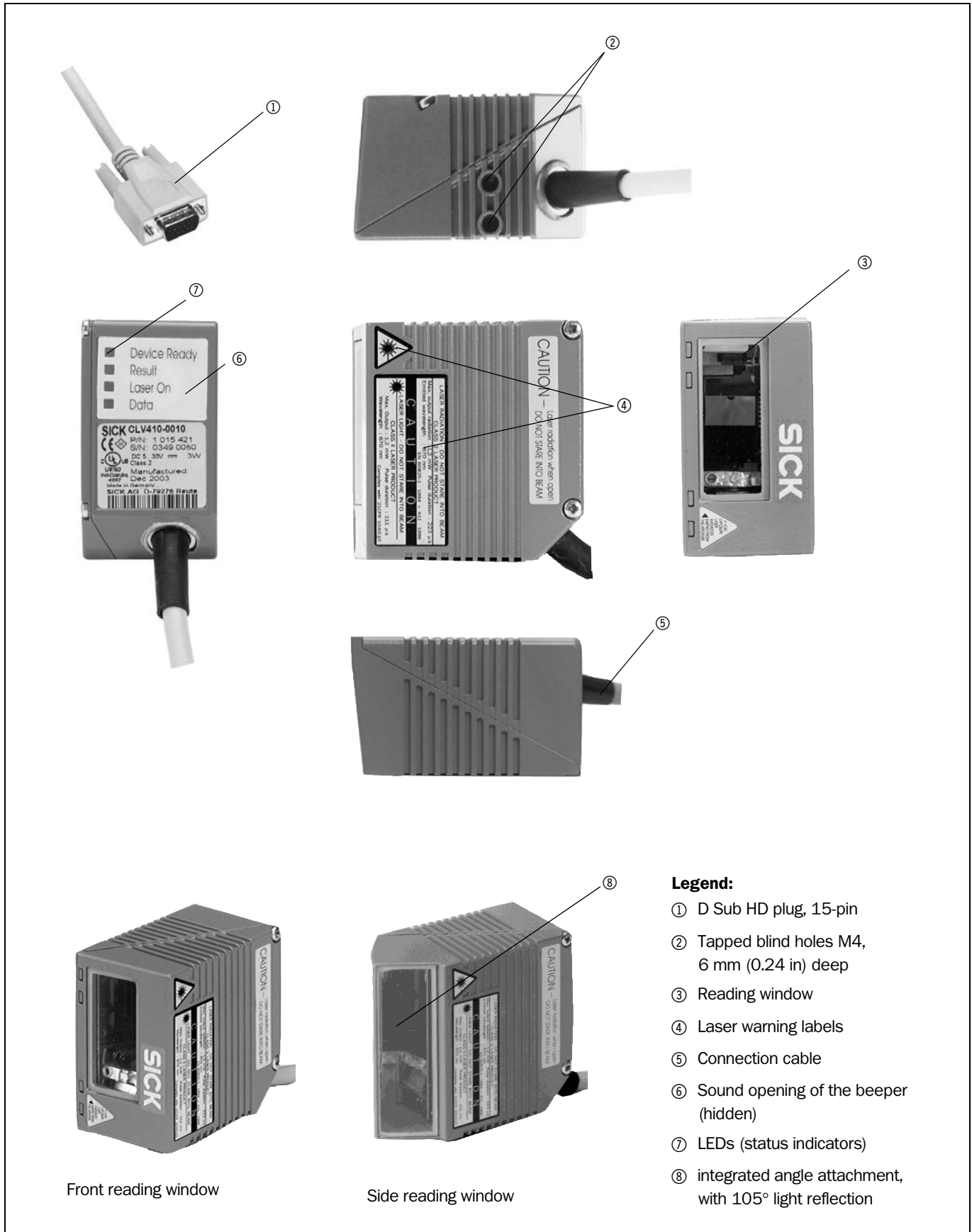

Fig. 3-1: CLV 41x line/raster scanner with/without 105° angle attachment

3.2 Method of operation

The CLV first scans the bar code with a scan line and then decodes it. The CLV forwards the data via the serial host interface to a host/PC for further processing. An overview of the CLV functions is provided in Fig. 3-2.

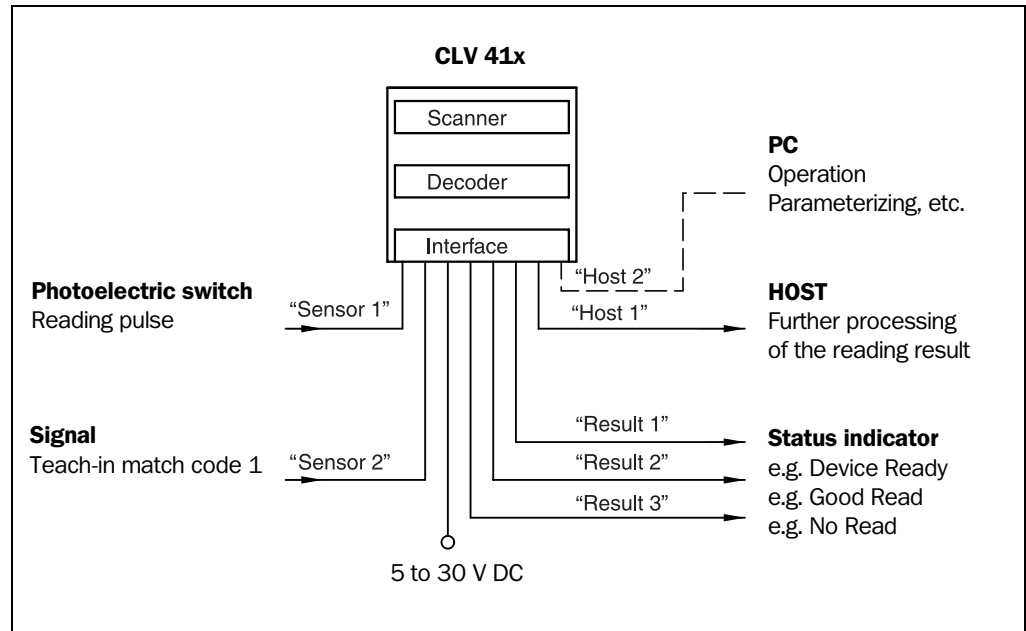

Fig. 3-2: Block diagram: CLV functions

The tried and tested standard decoder of the CLV series is available for decoding.

The CLV derives useful diagnosis data from the reading process and transfers it to the host. It also records operating data that can be interrogated at any time. The quality of the read can be checked in "Percentage Evaluation" mode.

To start a reading process when an object is located in the reading field, the CLV requires a suitable trigger. This opens a time window ("reading interval") in the CLV for the reading procedure. In the default setting, this trigger is supplied by the automatic reflector polling. Alternative trigger sources include external reading pulse sensor, free-running mode or a command via the host interface 1 (RS 422/485).

The current operating status is indicated by four LEDs.

A beeper indicates the status of the reading result. In the default setting, the "Good Read" function is selected for this.

If the trigger is supplied externally by a sensor, the "Sensor 1" switching input signals the start of the reading procedure to the CLV. The "Sensor 2" switching input can be used to teach in a match code. The "Result 1" to "Result 3" switching outputs can be assigned various functions and trigger external devices, such as a PLC.

The CLV is operated and configured via the host interface 2 (RS 232) using the "CLV Setup" software or via one of the host interfaces and command strings. The CLV can also be configured using profile bar codes.

The optional outputting of the error status ST via the host interface helps you with configuration and with locating the source of errors during startup and in reading mode.

3.2.1 Scan procedure variants

Line scanner

Generates a scan line. Due to the V-principle of beam deflection, the reading field height (for evaluating the useful length of the scan line) is dependent on the reading distance.

Raster scanner

Generates 8 parallel scan lines that are offset by the same distance. Due to the V-principle of beam deflection, the reading field height (for evaluating the useful length of the scan lines) is dependent on the reading distance.

Raster height of the scan line field: 15 mm (0.59 in) at a reading distance of 200 mm (7.88 in) (front reading window).

3.3 Indicators and operating elements

3.3.1 Operating elements

The CLV is operated and configured via the host interface 2 using the "CLV Setup" program or using command strings sent to one of the host interfaces. A variety of parameterizing options allow you to adapt the device to a wide range of applications.

The following can be defined (among others):

- the configuration of the code types to be read
- the reading, evaluation and output characteristics
- the communication parameters of the host interface
- the structure of the data output string for "good read" and "no read" on the host interface

Chapter 10.3 Installation and operating instructions for the PC-based "CLV Setup" program, Page 10-5 describes the procedure for installing the "CLV Setup" program and how to operate the user interface. Configuration (parameterizing) is explained in Chapter 6.4 Configuration (parameterizing), Page 6-4.

3.3.2 Function of the LED indicators

Four LEDs indicate the operating status, activity of the laser diode, output of the reading result, and data transfer on the host interface. The LED indicators (*Fig. 3-3*) are located on the rear of the device. *Table 3-2* shows the meaning of the LED indicators in the different operating modes/functions.

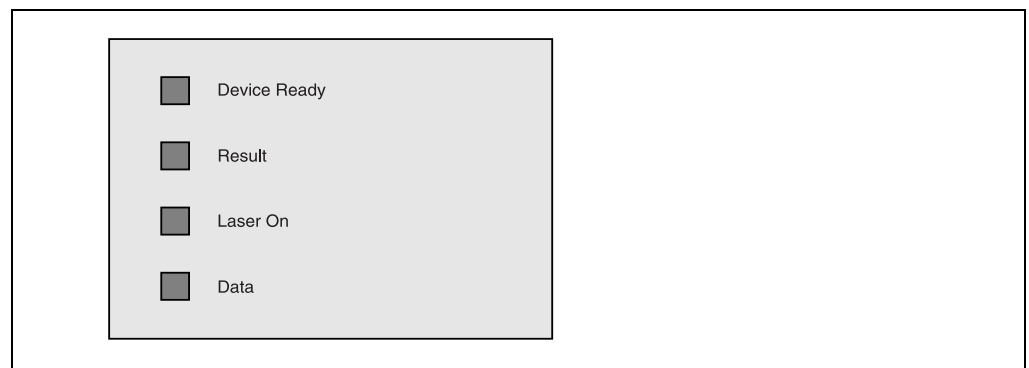

Fig. 3-3: LED indicators

Operating mode	LED	Indication	Function
Start	Device Ready	<i>green</i>	<ul style="list-style-type: none"> lights up after power-up if the self-test was successful and the wait time for reading the profile bar codes has expired
	Laser On	<i>green</i>	<ul style="list-style-type: none"> lights up while the laser diode for reading the profile bar codes is active
Reading mode	Device Ready	<i>green</i>	<ul style="list-style-type: none"> illuminates constantly extinguishes with new operating mode/function
	Laser On	<i>green</i>	<ul style="list-style-type: none"> lights up if reading diode active (The laser diode is activated/deactivated by reading pulse) lights up constantly in the pulse modes "Free running" and "Continuous Read", as the laser diode is always active lights up with every 20th scan in the "Reflector polling" pulse mode. The scan line is faintly visible.
	Result	<i>green</i>	<ul style="list-style-type: none"> lights up after a good read until the end of the next reading pulse lights up (match code comparison active) if the read bar code matches the predefined match code(s) The LED is not connected to any of the switching outputs
	Data	<i>yellow</i>	<ul style="list-style-type: none"> flickers while the CLV transfers data to the host on the host interface
Percentage evaluation and Read rate Evaluation	Laser On	<i>green</i>	<ul style="list-style-type: none"> lights up constantly (Free Running mode)
	Result	<i>green</i>	Behavior depends on the reading quality: <ul style="list-style-type: none"> extinguishes if reading rate < 30 % blinks twice a second if reading rate 30 % to 70 % blinks five times a second if reading rate 70 % to 90 % lights up constantly if reading rate > 90 %
Profile programming	Laser On	<i>green</i>	<ul style="list-style-type: none"> lights up while the profile bar codes are being read (Free Running mode)
AutoSetup	Laser On	<i>green</i>	<ul style="list-style-type: none"> lights up while the application-specific bar codes are being read (Free Running mode)

Table 3-2: Meaning of the LED indicators

3.3.3 Function of the beeper

The beeper uses different tone sequences and lengths (*Table 3-3, Page 3-9*) to signal whether functions have been executed successfully and whether any malfunctions have occurred.

For information on troubleshooting, see *Chapter 8.4 Troubleshooting, Page 8-3*.

In the default setting, the beeper indicates the event status "Good Read" by means of a "Low" (quiet) beep. It is assumed in these operating instructions, that the beeper is operated with the default setting in Reading mode.

The sound opening of the beeper is located on the rear, narrow side of the device and below the LED labeling.

Operating mode	Tone sequence	Beeper function
Start	Beep	<ul style="list-style-type: none"> signals that the self-test after power-up was successful
Reading mode	Beep Beep	<ul style="list-style-type: none"> confirms that the device has assumed Reading mode after power up and after the wait time of 5 s for reading the profile bar codes has elapsed
	Beep	<ul style="list-style-type: none"> confirms a successful read (good read; default setting) and the reading result output
Percentage Evaluation	–	<ul style="list-style-type: none"> the beeper does not confirm the reading
Read Rate Evaluation	Beep Beep ...	Behavior depends on the reading quality: <ul style="list-style-type: none"> repeat frequency 1 Hz, if reading rate < 30 % repeat frequency 2 Hz, if reading rate 30 % to 70 % repeat frequency 5 Hz, if reading rate 70 % to 90 % continuous tone, if reading rate > 90 %
Profile programming Start AutoSetup	Beep	<ul style="list-style-type: none"> confirms successful read of profile bar code for start/end of AutoSetup
	Beep Beep	<ul style="list-style-type: none"> confirms successful read of application-specific bar code and start of reading mode
	Beep Beep Beep	<ul style="list-style-type: none"> signals after approx. 35 s that the application-specific bar code was not read
Profile programming	Beep	<ul style="list-style-type: none"> confirms successful read of profile bar code
	Beep Beep	<ul style="list-style-type: none"> confirms start of reading mode 10 s after last profile bar code was read
Exceeding the laser timeout	Beep Beep Beep	<ul style="list-style-type: none"> signals that the laser diode has been deactivated after the laser timeout of 10 min (default setting) was exceeded in Reading mode. The reading pulse is still active.

Table 3-3: Beeper function



Tip The behavior of the beeper in **reading mode** can be changed on the DEVICE CONFIGURATION tab in the CLV Setup program.

Volume:

- Click the required field in the RESULT OUTPUT/BEEPER VOLUME section.

Note In all other operating modes the beeper volume is fixed independently of the setting.

Output function for the result status:

1. Click the RESULT OUTPUT PARAMETERS button in the RESULT OUTPUT section. The RESULT OUTPUT PARAMETERS dialog box is displayed.
2. Click the BEEPER list field in the RESULT FUNCTIONS section. The list containing the available result status functions appears.
3. Click the required function and confirm with "OK".
4. Perform a download to the CLV. This is done by clicking  in the toolbar. The DOWNLOAD PARAMETER dialog box is displayed.
5. Confirm the dialog box by selecting the PERMANENT save option.

The CLV operates the beeper with the values selected for the result status indication and volume.

Note In "Percentage Evaluation" and "Read Rate Evaluation" mode, the switching outputs do not output any signal.

Notes

4 Installation

4.1 Overview of installation sequence

- Change the language version of the laser warning label (if necessary)
- Select the installation location for the CLV
- Align the CLV with the bar code
- Align the CLV with the polling reflector for internal reading pulse triggering
- Mount the CLV
- Install the CDB 410 or CDM 410 connection module
- Connect the CLV to the CDB 410 or CDM 410 connection module
- Adjust the CLV
- Alternative: Install the reading pulse sensor for external triggering the reading pulse

Note Don't open the device. The producer warranty will be forfeited if the device is opened.

4.2 Installation preparations

4.2.1 Laying out required components to be installed

- CLV 41x bar code scanner

4.2.2 Laying out accessories

- Small mounting bracket no. 2 020 077 or large mounting bracket no. 2 020 078 with 2 x M4 x 8 mm (0.32 in) screws for installing the bracket to the CLV (not included with the CLV)

– or –

Alternatively, if the bracket is supplied by the user:

- Stable installation device that allows the alignment of the CLV to be varied in the x and y axes. The maximum weight of the CLV (line/raster scanner) is 250 g (8.8 oz), or approx. 320 g (11.3 oz) with additional attachment (with cable).
 - Two M4 screws for the CLV. The screw length depends on the wall thickness of the bracket used. Depth of engagement in CLV **max. 6 mm** (0.24 in) from housing surface.
 - CDB 410 or CDM 410 connection module (not included with CLV)
 - Polling reflectors for automatic internal generation of the reading pulse trigger
- or –
- Reading pulse sensor for external reading pulse trigger, e.g. photoelectric reflex switch/photoelectric proximity switch (not included with the CLV)

4.2.3 Laying out other required materials

- Two M4 screws for securing the SICK mounting bracket to the base. The screw length depends on the wall thickness of the base.
- Set of laser warning labels (if necessary)
- Tools
- Measuring tape (up to 1 m (39.4 in))
- Protractor

4.2.4 Replacing the laser warning label

If necessary, replace the laser warning label in GB English/US English on the CLV with the required language (Fig. 4-1).

The device is delivered with a set of laser warnings in:

- German/US English
- French/US English

See also Chapter 2.3 General safety instructions and protection measures, Page 2-2.

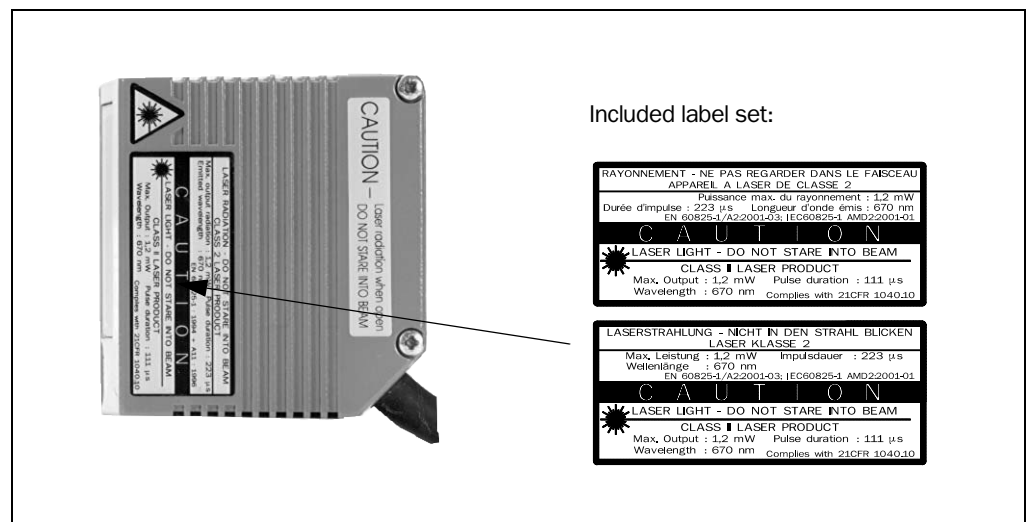

Fig. 4-1: Example line scanner: replacing the laser warning label

4.2.5 Selecting the installation location

When you select the installation location, the distance between the CLV and the host and between the CLV and the bar code are important.

Distance between the CLV and the host

The CLV can be installed without a connection to a bus connection max. 1,200 m (3,936.9 ft) away from the host. The distance which can be achieved depends on the selected type of the host interface and the set data transfer rate, however.

See Table 5-2, Page 5-3.

Distance between the CLV and the CDB 410 or CDM 410 connection module

The CDB 410 or CDM 410 connection module must not be located further than 10 m (32.8 ft) from the CLV, since the "CLV Setup" program on the PC accesses the host interface 2 of the CLV via the module (RS 232).

4.2.6 Mounting accessories

The CLV is mounted with the help of two tapped blind holes (M4) located on the bottom narrow side of the device. Fig. 4-2 shows the position of the threaded hole for both housing models. The complete dimensions of the CLV housing are shown in Fig. 9-1, Page 9-3.

CLV 41x bar code scanner

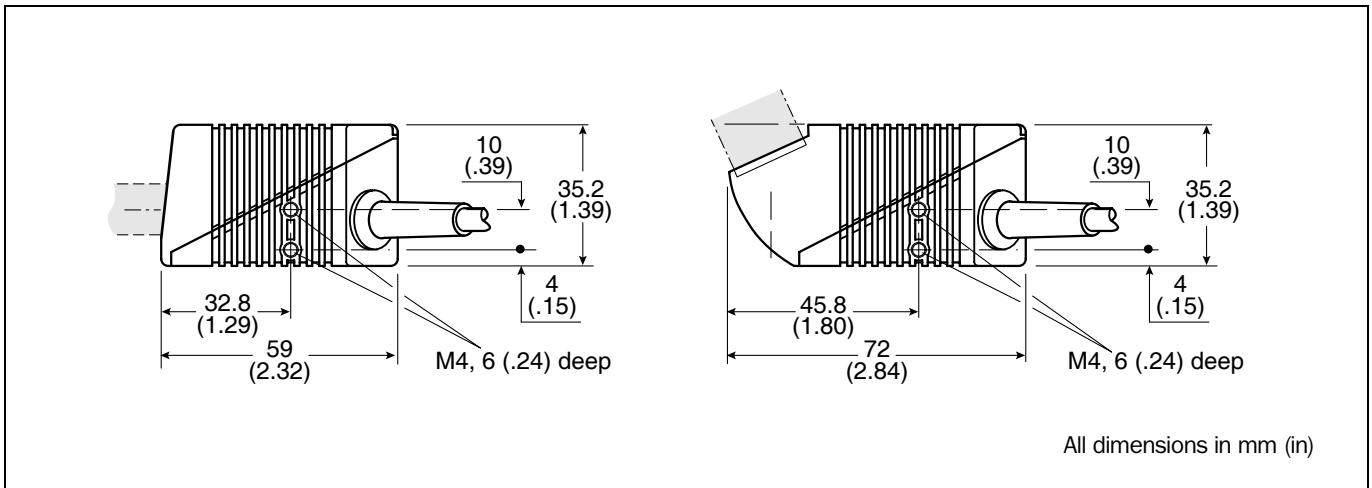

Fig. 4-2: Location of the securing threads on the CLV

The CLV can be installed using the following SICK brackets:

- Small mounting bracket, no. 2 020 077
- Large mounting bracket, no. 2 020 078

The brackets are designed to support a variety of installation positions and alignments of the CLV in two planes. Fig. 4-3 shows a mounting example.

The slots in the brackets allow a turning freedom of $\pm 15^\circ$ for the fine adjustment of the CLV.

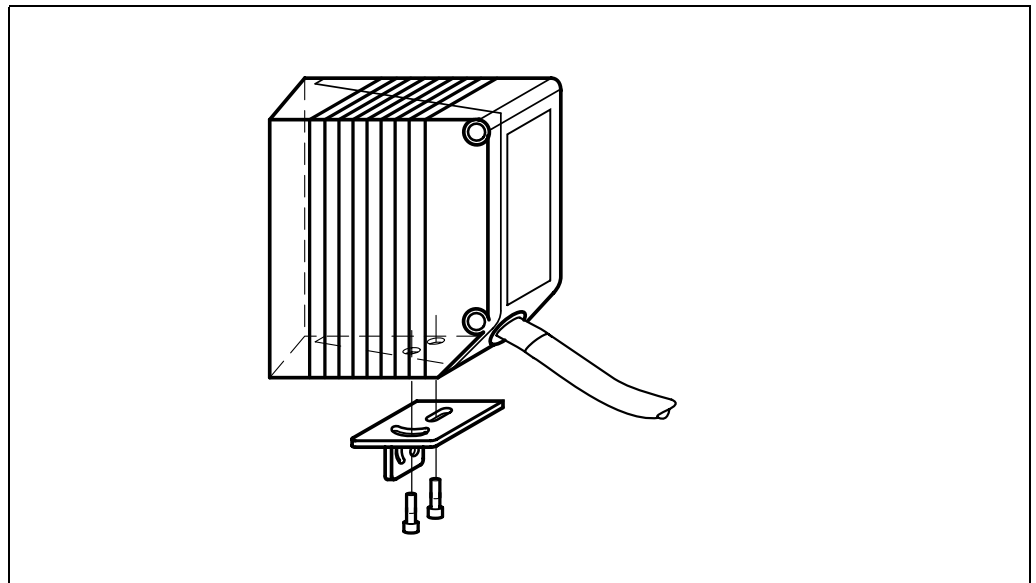

Fig. 4-3: Installation example: mounting the CLV with mounting bracket no. 2 020 077

4.2.7 Distance between the CLV and the bar code

Basic alignment of the scan line to the bar code

Depending on the application, the line scanner or raster scanner version of the CLV is used. Fig. 4-4 shows how the device is aligned with the bar code on the object for each of the two scanning methods.

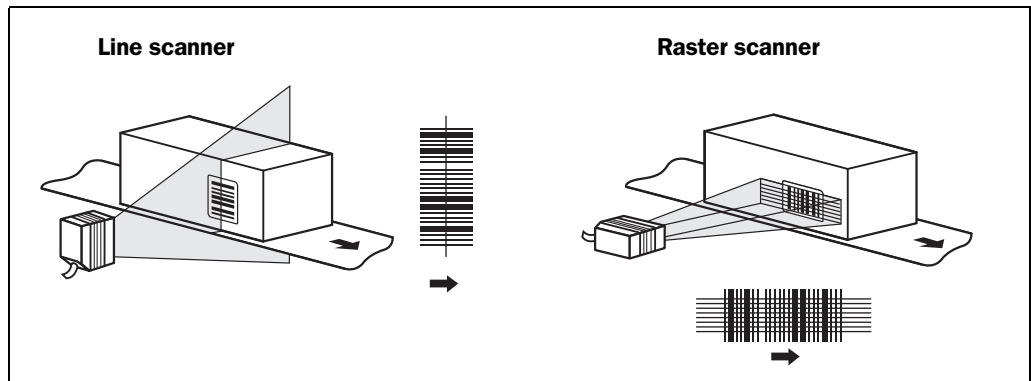

Fig. 4-4: Scanning methods: alignment with bar code and conveyor direction

Reading distance between bar code and aperture angle α

The distance between the reading window of the CLV and the bar code must not exceed the technical limits. The height of the reading field is shown as a function of the reading distance “a” for various resolutions (module widths) in Chapter 10.2 Specification diagrams, Page 10-1.

Fig. 4-5 shows the definition of the reading distance “a” from the reading window and of the aperture angle α for each of the two scanning methods.

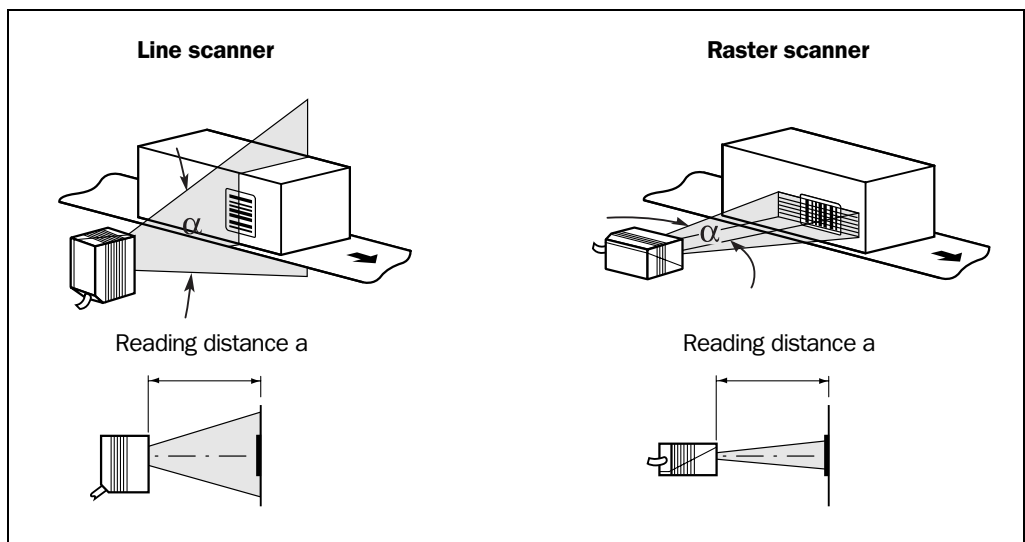

Fig. 4-5: Definition of the reading distance a and the aperture angle α

For both scanning methods, the useable aperture angle α is **max. 60°** with front reading window and **max. 50°** with side reading window (additional 105° angle attachment). Due to the V-principle of beam deflection, the reading field height (for evaluating the useful length of the scan line) depends on the reading distance.

Angular alignment of the CLV

Optimum alignment of the CLV is achieved when the scan line travels over the bar code lines almost at a right angle (90°) (Fig. 4-4). All possible reading angles that can occur between the scan line and the bar code must be taken into consideration (Fig. 4-6 and Table 4-1).

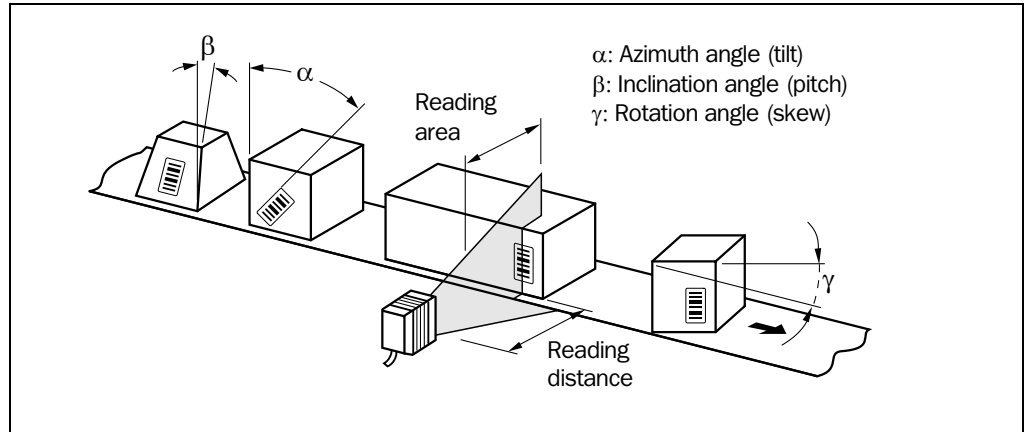

Fig. 4-6: Line scanner: reading angles between the scan line and the bar code

Angle	Limit
Azimuth α (tilt)	max. 15° (depending on the code print)
Inclination β (pitch)	max. 45° (depending on the module width)
Skew γ	max. 45° (depending on the module width)

Table 4-1: Permissible reading angles between the scan line and bar code

Preventing surface reflection

If the light from the scan line strikes the surface of the bar code perpendicularly, interference may be caused by reflections when the returned light is received. To prevent this effect, the CLV must be installed in such a way that the emitted light is tilted slightly with respect to the vertical axis. Fig. 4-7 shows an example of this using the line scanner.

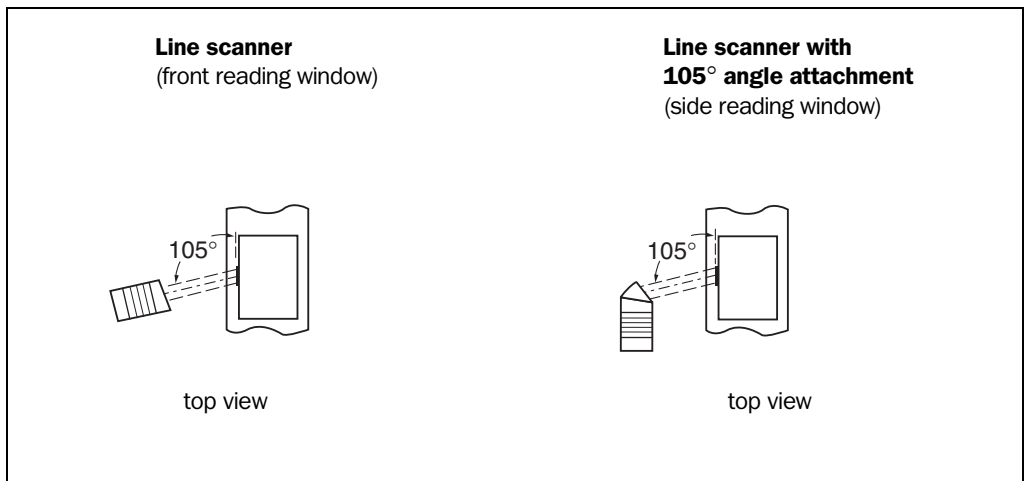

Fig. 4-7: Preventing surface reflection: angle between the emitted light and bar code (tilted away from the vertical axis)

The laser beam from the line/raster scanner with angle attachment is emitted at an angle of 105° with respect to the housing. Depending on the application, the device can also be installed flush with the conveyor belt.

4.2.8 Count direction of the code position CP

Explanation The CLV can scan and decode several bar codes with each read. In doing so, it determines the specific local reading diagnosis data for each bar code, i.e. the position (CP value) of the center of the bar code within the scan line.

Fig. 4-4 shows the count direction of the code position.

By determining the CP value, the device can separate identical bar codes (code type, code length, and data content) and assign the bar code data in the reading result to its position on the object.

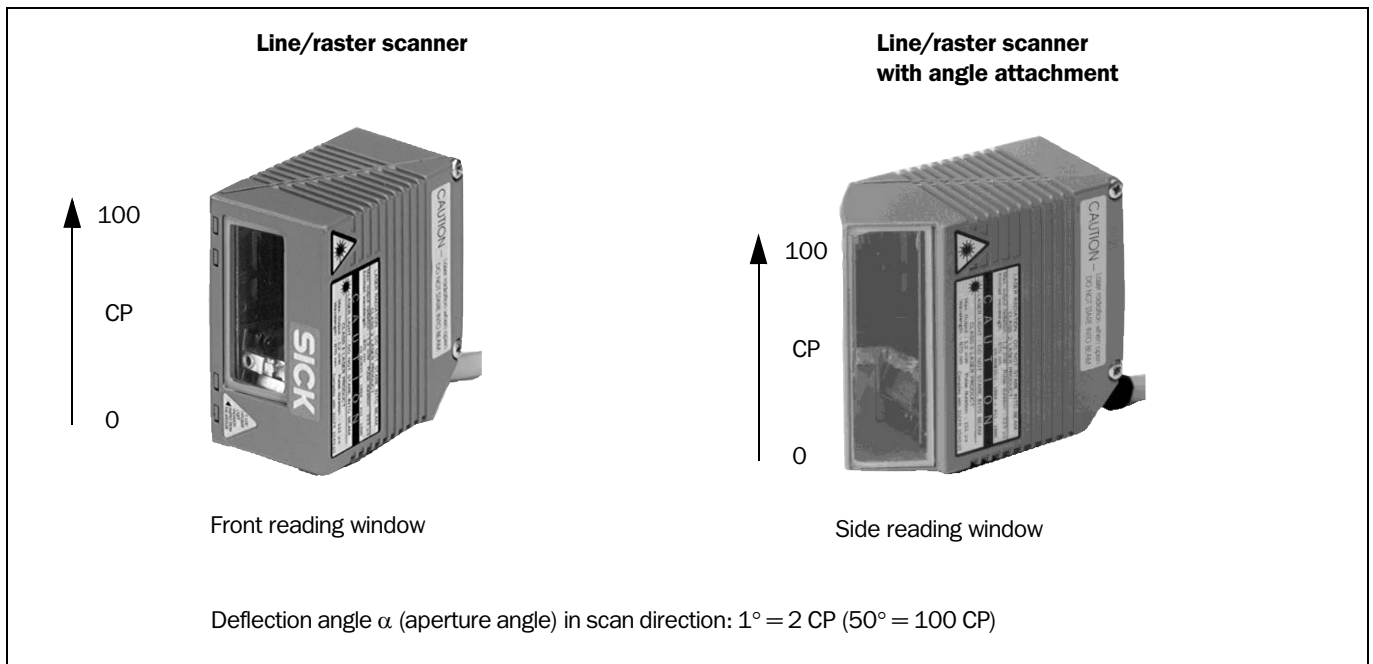



Fig. 4-8: Count direction of the code position CP within the scan line



Tip

In the default setting, the CLV does not output the value "CP" in the reading result of the host interface. If this is required to evaluate the result in the host, the values can be included in the Separator of the output string using the CLV Setup program.

Configuring the Separator:

1. Select the DATA STRINGS tab.
2. Click the SEPARATOR field.
The dialog window EDIT PARAMETER: TFS dialog box is displayed.
3. In the drop-down list, click the CP parameter.
CP then appears on the top line.
4. Confirm the dialog box with "OK".
5. Perform a download to the CLV. This is done by clicking  in the toolbar.
The DOWNLOAD PARAMETER dialog box is displayed.
6. Confirm the dialog box by selecting the PERMANENT save option.
The CLV outputs the CP value for each bar code in the reading result via the host interface. The values are displayed as a 3-digit number in the associated Separator.

4.3 Installing and adjusting the device

4.3.1 Installing the CLV

1. Prepare the base for installing the bracket as described in *Chapter 4.2.2 Laying out accessories, Page 4-1*.
2. Place the object containing the bar code within the visible range of the CLV (in the position at which it is to be read) with the conveyor belt switched off.
3. Align the CLV with the bar code (in accordance with the scanning method) in such a way that
 - with the line/raster scanner, the narrow end with the LED indicators is almost parallel with the bar code surface
 - with the line/raster scanner with angle attachment, the wide side with the laser warning labels is almost parallel with the bar code surface
 All of the possible reading angles must be taken into consideration. See *Fig. 4-6, Page 4-5*.
4. If relevant to the evaluation, pay attention to the count direction of the code position if applicable. See *Fig. 4-8, Page 4-6*.
5. Install the CLV bracket on the base.



Risk of damage to the device

The maximum depth of engagement of the two tapped blind holes M4 is 6 mm (0.24 in). Longer screws will damage the device.

- Use screws with the correct length.

6. Screw the M4 screws through the bracket into the tapped blind holes of the CLV.
7. Tighten the screws slightly.
8. Adjust the CLV as described below.

4.3.2 Adjusting the CLV



The "percentage evaluation" mode supports the adjustment of the CLV. In this mode, the CLV displays the quality of the bar code reads that enter the CLV reading field statically (the object is not moved on the conveyor belt). The CLV performs 100 scans in Free Running mode and evaluates the reading quality statistically. It outputs the reading result continuously every 2 s via the host interfaces.

The behavior of the "Result" LED also indicates the reading quality:

- LED is extinguished if reading quality is < 30 %
- LED flashes twice per second if the reading quality is 30 % to 70 %
- LED flashes five times per second if the reading quality is 70 % to 90 %
- LED is lit continuously if the reading quality is > 90 %

1. Connect the CLV to the CDB 410 or CDM 410 connection module and switch on the power supply to the module (see *Chapter 5.5.3 Connecting the power supply, Page 5-5*).

Once the CLV has started, it outputs a tone to indicate that the self-test was successfully completed. Shortly afterwards, it outputs two tones to indicate that it has assumed Reading mode. The "Device Ready" LED lights up.

2. Connect the PC to the host interface 2 of the CLV. For this purpose, connect a 3-core RS 232 data cable (null modem cable) to the internal 9-pin "Aux" plug of the module (see *Chapter 5.5.5 Connecting the PC to the host interface 2 (RS 232), Page 5-7*).
3. Start Windows and "CLV Setup" on your PC (see *Chapter 10.3.3 Starting "CLV Setup", Page 10-8*).



Activating "Percentage Evaluation" mode:

4. From the VIEW menu, choose PERCENTAGE EVALUATION.
The Terminal Emulator is launched and displays the reading result continuously (see *Chapter 6.5.2 Percentage evaluation, Page 6-17*).
Monitor the **reading quality** (%) during each of the subsequent steps!

Performing fine adjustment:

5. Align the CLV in such a way that the angle between the scan line and the bars on the bar code CLV is almost 90°.
6. To prevent interfering reflections, tilt the CLV away from the vertical axis so that the light strikes the bar code at an angle of approx. 105° (line scanner) (*Fig. 4-7, Page 4-5*).
7. If necessary, position the center of the red scan line exactly on the bar code (see *Chapter 4.4 Installing external components, Page 4-8*).
8. Move objects carrying bar codes into the CLV reading field manually under realistic conditions and check the reading result. If the objects are aligned randomly, or if the bar code is located at different positions (angles), ensure that the limit values of the permissible reading angles are not exceeded.
9. Adjust the CLV in such a way that the good read rate is between **70 and 100 %**.
10. Tighten the screws on the CLV.

The CLV is aligned with the bar code.

4.4 Installing external components

4.4.1 Installing the CDB 410 or CDM 410 connection module

1. Install the CDB 410 or CDM 410 connection module near the CLV. The distance between the connection module and CLV must not exceed 10 m (32.8 ft).
2. Install the CDB 410 or CDM 410 in such a way that the device can be accessed when opened. The host interface 2 (RS 232) of the CLV is accessed via the internal 9-pin "Aux" connector.



Detailed information on the installation and electrical installation procedures is provided in the "CDB 410 Connection Module" *Operating Instructions* (order no. 8 010 000, German/English version) respectively in the "CDM 410 Connection Module" *Operating Instructions* (order no. 8 010 003, German/English version).

4.4.2 Installing the polling reflector

The reading pulse can also be triggered by the presence of an object in the reading field, independent of an external reading pulse sensor, by using the "Reflector Polling" pulse mode of the CLV. In order to do so, attach one of the two polling reflectors (special bar codes) included with the device opposite the CLV behind the conveyor belt (*Fig. 4-9*). *Table 4-2* lists the permissible range values for the polling reflectors. The pulse type is selected in the default setting.

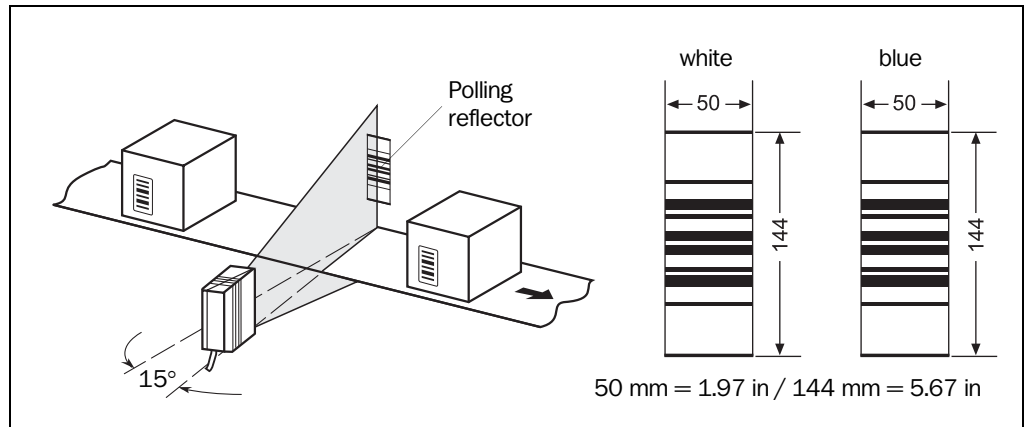

Fig. 4-9: Line scanner: installation location of the polling reflector

Device type	Reflector	Range (scanning frequency 500 Hz)
CLV 410	white	40 to 500 mm (1.58 to 19.7 in)
	blue	500 to 800 mm (19.7 to 31.5 in)
CLV 412	blue	150 to 350 mm (5.9 to 13.8 in)
CLV 414	blue	230 to 650 mm (9 to 24.4 in)

Table 4-2: Permissible range values for the polling reflectors

Explanation When reflector polling is used, the CLV activates the laser diode with every 20th scan and checks whether it detects the reflector. If the reflector is visible, the CLV repeats the procedure after the next 20 scans. If the reflector is concealed by an object entering the reading field, the CLV starts the reading pulse. This pulse ends when the CLV detects the reflector again. Following this, the CLV repeats the above procedure. When the CLV is switched on, the polling reflector must be visible before the first reading pulse can start. The CLV does not output the data content of the polling reflector in "Reading" mode.

Note This pulse mode is **not** suitable for applications where time is critical. The max. delay between the reliable detection of the reflector and the start of the internal reading interval is approx. 100 ms at a scanning rate of 200 Hz.

Adjusting the polling reflector roughly:

1. Connect the CLV to the CDB 410 or CDM 410 connection module and switch on the power supply to the module (see *Chapter 5.5.3 Connecting the power supply, Page 5-5*).
Once the CLV has started, it outputs a tone to indicate that the self-test was successfully completed. Shortly afterwards, it outputs two tones consecutively to indicate that it has assumed Reading mode. The "Device Ready" LED lights up.
2. Align the CLV optimally with the bar code on the object (see *Chapter 4.3.2 Adjusting the CLV, Page 4-7*).
3. Choose a suitable polling reflector for the device type, as shown in *Table 4-2*. Other ranges available on request.
4. Secure the polling reflector directly opposite the CLV on a suitable base (movable bracket, wall) temporarily so that the CLV has an unobstructed view of the reflector in the gaps between the objects and can scan them reliably. The reflector must be in the center of the scan line, see *Fig. 4-9*.



Activating "Percentage Evaluation" mode:

- From the VIEW menu, choose PERCENTAGE EVALUATION.
The Terminal Emulator is launched and displays the reading result continuously (see Chapter 6.5.2 Percentage evaluation, Page 6-17).

Fine-adjusting and securing the polling reflector:

- Align the reflector with the CLV (not vice versa!) until a good read rate of **95 to 100 %** is reached. In doing so, prevent any surface reflection (see Chapter 4.2.7 Distance between the CLV and the bar code, Page 4-4).
The CLV outputs the data content of the unconcealed polling reflector with the identifier "REPO".
- Once the device is in the final attachment position, remove the protective film from the rear of the reflector and stick it to the base.
- Check whether the device operates correctly with objects moving under realistic conditions on the conveyor belt. Readjust the reflector if necessary.

Activating "Reflector Polling pulse" mode in the CLV (N/A with default setting):

- Select the DEVICE CONFIGURATION tab.
- Click the READING TRIGGER PARAMETERS button.
The READING TRIGGER PARAMETERS dialog window is displayed.
- Activate the REFLECTOR POLLING option in the READING TRIGGER SOURCE section.
- Confirm the dialog box with "OK".
- Perform a download to the CLV. This is done by clicking  in the toolbar.
The DOWNLOAD PARAMETER dialog window is displayed.
- Confirm the dialog window by selecting the PERMANENT save option.
The CLV is then operating in the "reflector polling" pulse mode.

4.4.3 Alternative: Installing the external reading pulse sensor

If the CLV is triggered by an external reading pulse sensor, the sensor must be mounted in the vicinity of the CLV and be connected to the "sensor 1" switching input. The pulse type is **not** selected in the default setting.

Fig. 4-10 shows two examples of where a photoelectric reflex switch can be installed. This depends on the distance a from the bar code to the front edge of the object. Depending on the application, you may need to attach the sensor in such a way that bar codes on objects of different sizes can be read completely during the reading interval.

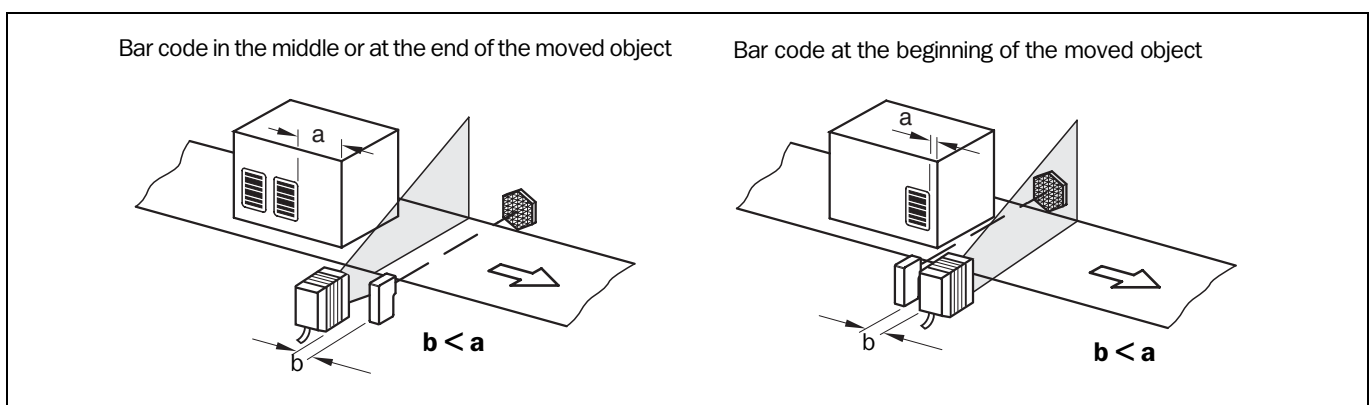



Fig. 4-10: Line scanner: installation example for the external reading pulse sensor



1. Attach the reading pulse sensor to the installation location.
2. Connect the reading pulse sensor to the "Sensor 1" switching input of the CLV via the CDB 410 or CDM 410 connection module (see *Chapter 5.5.6 Connecting the "Sensor 1" switching input*, Page 5-10).
3. Connect the CLV to the CDB 410 or CDM 410 connection module and switch on the power supply to the module (see *Chapter 5.5.3 Connecting the power supply*, Page 5-5).
After the CLV has started, it emits a tone to indicate that the self-test was successful. After a short while, it outputs two consecutive tones to indicate that it has switched to Reading mode. The "Device Ready" LED lights up.
4. Connect the PC to the host interface 2 of the CLV. For this purpose, connect a 3-core RS 232 data cable (null modem cable) to the internal 9-pin "Aux" plug of the module. (See *Chapter 5.5.5 Connecting the PC to the host interface 2 (RS 232)*, Page 5-7.)
5. Start Windows and "CLV Setup" on your PC (see *Chapter 10.3.3 Starting "CLV Setup"*, Page 10-8).

Parameterizing an external sensor as a trigger source:

6. Select the DEVICE CONFIGURATION tab.
7. Click the READING TRIGGER PARAMETERS button.
The READING TRIGGER PARAMETERS dialog window is then displayed.
8. Choose SENSOR INPUT (ACTIVE HIGH) in the READING TRIGGER SOURCE section and activate the dialog box.
9. Perform a download to the CLV. This is done by clicking  in the toolbar.
The DOWNLOAD PARAMETER dialog window is displayed.
10. Confirm the dialog window by selecting the PERMANENT save option.
The CLV operates with the "Sensor 1" switching input as an external trigger source.
The reading pulse starts when power is applied.

Carrying out a test reading:

11. From the VIEW menu, choose READING MODE.
The Terminal Emulator window is then displayed. The CLV is in Reading mode.
Monitor the reading result during each of the subsequent steps!
12. Move objects with bar codes into the CLV reading field manually under realistic conditions.
13. Check whether the reading result and trigger pulse are correct.
14. Repeat the procedure with the conveyor switched on.
Check whether the reading procedure is synchronized with the approaching objects.

4.5 Removing the device

1. Switch off the power supply to the CDB 410 or CDM 410 connection module.
2. Loosen the screws and remove the CLV connector from the connection module.
3. Unscrew the CLV from the installation device.

When removing the device from service for the last time, please dispose of it in an environmentally-friendly manner, as described in *Chapter 7.3 Disposal*, Page 7-2.

Notes

5 Electrical connection

5.1 Overview of the connection sequence

- Connect the CLV to the SICK CDB 410 or CDM 410 connection module
- Connect the data and function interfaces of the CLV in the module
- Connect the PC to the connection module (at the host interface 2 of the CLV)
- Connect the power supply to the connection module

5.2 Electrical connections and cables

The electrical connection for the CLV consists of a 15-pin D Sub HD plug. It supplies the following interfaces:

- two serial data interfaces (host interface 1 and 2)
 - two switching inputs (external reading pulse and multifunctional input)
 - three switching outputs (for result status functions, or connecting to a PLC for example)
 - power supply
- Wire all the connections with copper cables with a minimum wire diameter of 0.09 mm² (approx. 17 AWG)!

5.2.1 Connections/cables for the CDB 410 or CDM 410 connection module

The CDB 410 or CDM 410 connection module is suitable for connecting the CLV to peripherals (distribution function) and the power supply. The module can be used to establish a connection to the host (point-to-point) or to integrate the device in a SICK Network (RS 485) or daisy-chain configuration (pass-through or master/slave configuration).

Fig. 5-1 shows the connection principle of the CDB 410 or CDM 410 for one CLV.

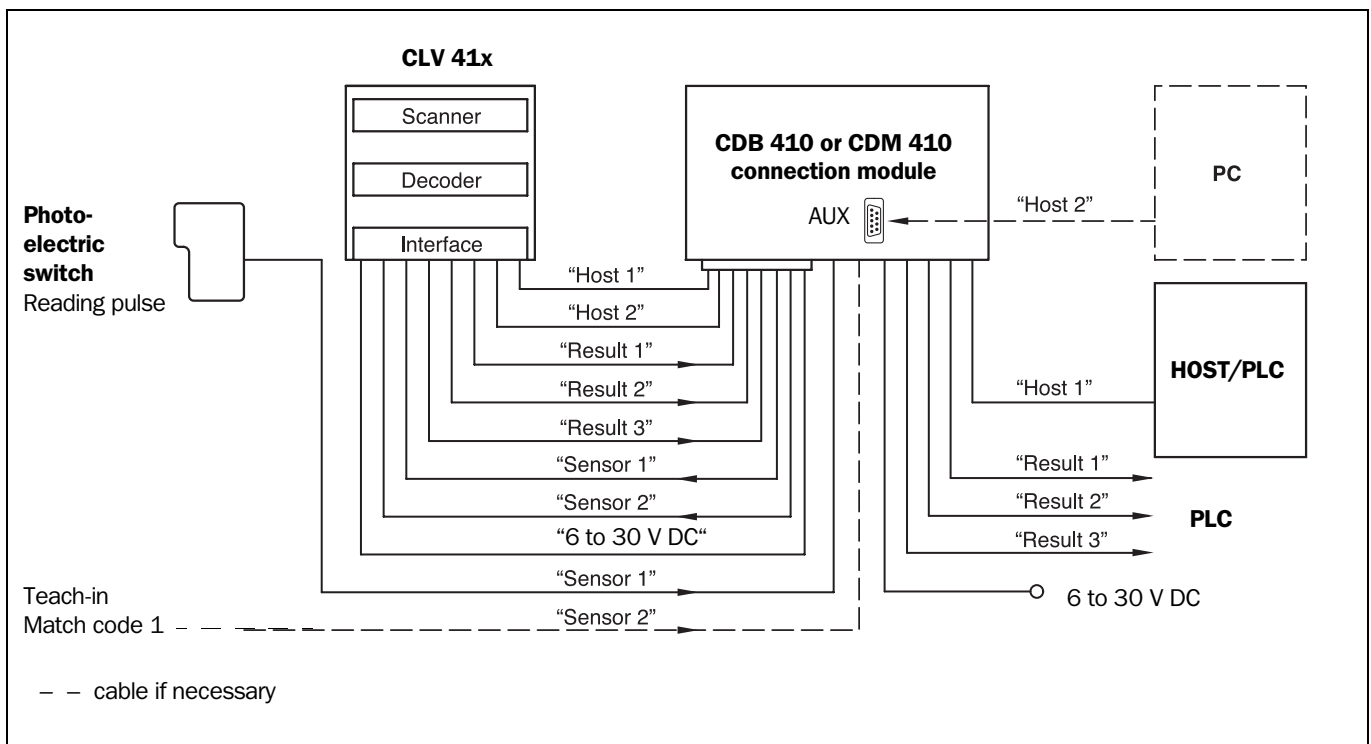

Fig. 5-1: Block diagram: connection of the CLV to the CDB 410 or CDM 410 connection module



Connect and configure the CDB 410 or CDM 410 Connection Module as described in the “CDB 410 Connection Module“ *Operating Instructions (order no. 8 010 000, German/English version)* respectively in the “CDM 410 Connection Module“ *Operating Instructions (order no. 8 010 003, German/English version)*.

Note Diagramms showing you how to connect the CDB 410 and CDM 410 Connection Modules are also available in the “CLV Connect“ PC program. This software is available on the “Manuals & Software“ CD ROM, which is included in the scope of delivery of the ICR. The software can also be downloaded from the SICK home page (www.sick.de) at “Service& Support/ Downloadpool“. It can be called up using a standard HTML browser (e. g. Internet Explorer™).

5.3 Connector pin assignment

Pin	Signal	Function
1	5 to 30 V DC	Power supply
2	Sensor 2	Switching input Teach-in (match code)
3	Result 3	Switching output, variable function
4	Term RS 422	Termination host interface 1
5	GND	Ground
6	RD+ (RS 422/485)	Host interface 1 (receiver)
7	RD- (RS 422/485)	Host interface 1 (receiver)
8	TD+ (RS 422/485)	Host interface 1 (transmitter)
9	TD- (RS 422/485)	Host interface 1 (transmitter)
10	RxD (RS 232)	Host interface 2 (receiver)
11	TxD (RS 232)	Host interface 2 (transmitter)
12	Result 1	Switching output, variable function
13	Result 2	Switching output, variable function
14	Sensor 1	Switching input for external reading pulse
15	SensGND	Common ground for all inputs
–	–	Shield

Table 5-1: Pin assignment of the 15-pin D Sub HD plug

5.4 Preparations for electrical connection

5.4.1 Requirements for the host interface

The host interfaces of the CLV can be operated as RS 422/485 or RS 232 interface. *Table 5-2* shows the recommended maximum cable lengths as a function of the selected data transfer rate.

Interface type	Transfer rate	Distance from host
RS 232	up to 19,200 bd	max. 10 m (32.8.ft)
	38,400 to 57,600 bd	max. 3 m (9.84 ft)
RS 422/485 ¹⁾	max. 38,400 bd	max. 1,200 m (3,937 ft)
	max. 57,600 bd	max. 500 m (1,640 ft)

1) with suitable line termination according to specification

Table 5-2: Maximum cable lengths between the CLV and host

- To prevent interference, do not lay the cable parallel with power supply and motor cables over long distances, e.g. in cable ducts.

Note To meet the FCC-regulations, the cables have to shielded including connections from shielding to the connector casings.

5.4.2 Power supply

The CLV requires a power supply of 5 to 30 V DC (functional extra-low voltage) in accordance with the standard IEC 364-4-41. The functional extra-low voltage can be generated by using a safety isolating transformer pursuant to IEC 742. The CLV has a power consumption of max. 3 W (when switching outputs are not connected).

The CLV is supplied with 6 to 30 V DC via the CDB 410 or CDM 410 connection module. If the CMP 400 Power Supply Module is used in the CDM 410, a mains voltage of 100 to 250 V AC/50 to 60 Hz is required.

Note The CLV 41x is UL certificated when a class 2 power supply according to UL 1310 is used.

Power-up delay

The selected device number (default setting: 1) affects the power-up delay of the device. This is useful if a large number of CLVs (e.g. in the SICK Network) are supplied from one power source. *Table 5-3* contains a list of the available intervals.

Device number GN	Power-up delay	Device number GN	Power-up delay
1; 11; 21; 31	0 ms	6; 16; 26	2,000 ms
2; 12; 22	400 ms	7; 17; 27	2,400 ms
3; 13; 23	800 ms	8; 18; 28	2,800 ms
4; 14; 24	1,200 ms	9; 19; 29	3,200 ms
5; 15; 25	1,600 ms	10; 20; 30	3,600 ms

Table 5-3: Power-up delay as a function of the device number GN



Tip The device number can be selected on the DEVICE CONFIGURATION tab in the CLV Setup program.

5.4.3 Non-SICK power pack/connections without the SICK connection module

If a non-SICK power supply unit is used instead of the CDB 410 or CDM 410, it must provide a functional extra-low voltage in accordance with the standard IEC 364-4-41 and a continuous power output of at least 4 W.

The output circuit must be reliably electrically isolated from the input circuit. Do do so, use a safety isolating transformer pursuant to IEC 742.

The minimum wire cross-section for the power supply (pin 1/pin 5) is 0.15 mm² (approx. 26 AWG).

- Use the cable no. 6 010 137 with 15-pin D Sub HD socket and open wire ends to connect the CLV. The color assignment of the wires is shown in *Table 5-4, Page 5-4*.

Note The CLV 41x is UL certificated when a class 2 power supply according to UL 1310 is used.

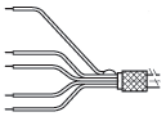

Pin	Signal	Wiring color
1	5 to 30 V DC	red
2	Sensor 2	purple
3	Result 3	yellow
4	Term RS 422	red/black
5	GND	black
6	RD+ (RS 422/485)	light blue
7	RD- (RS 422/485)	blue
8	TD+ (RS 422/485)	turquoise
9	TD- (RS 422/485)	green
10	RxD (RS 232)	gray
11	TxD (RS 232)	pink
12	Result 1	brown
13	Result 2	orange
14	Sensor 1	white
15	SensGND	white/black
-	Shield	white/green

Table 5-4: Wiring color assignment of cable no. 6 010 137 (open end)

5.5 Making electrical connections

5.5.1 Overview of connection procedure

- Connect the power supply
- Connect the host interface 1 or 2
- Connect the PC (connect the host interface 2)
- Connect switching input "Sensor 1" and, if necessary, "Sensor 2" as well
- Connect switching outputs "Result 1" to "Result 3"

5.5.2 Auxiliaries

- Tools
- Digital measuring device (current/voltage measurement)

5.5.3 Connecting the power supply

If the CLV is powered via the CDB 410 or CDM 410 connection module, the power supply does not have to be wired separately.

1. Ensure that the power supply to the connection module is switched off.
2. Connect the 15-pin plug on the CLV to the corresponding socket on the CDB 410 or CDM 410 and screw it tightly. The connection cable can be extended by 2 m (6.56 ft) using the extension cable no. 6 010 075.

The data and function interfaces of the CLV are connected to the connection module.

– or –

External power pack:

- Connect the power supply to the red wire (pin 1, +V_S) and the black wire (pin 5, GND) of cable no. 6 010 137. (See also Table 5-4.)

5.5.4 Connecting the host interface

The CLV provides two host interfaces in the combination RS 422/485 (interface 1) and RS 232 (interface 2), Fig. 5-2. Both interfaces operate parallel using identical communication parameters. One of the interfaces must be selected for permanent data communication with the host. If the RS 232 interface is not connected to the host, it can be used **exclusively** (e.g. with a PC) to monitor data traffic on the parallel RS 422/485 interface. The CLV is configured via the interface 2 by temporarily connecting a PC (see Chapter 5.5.5 Connecting the PC to the host interface 2 (RS 232), Page 5-7).

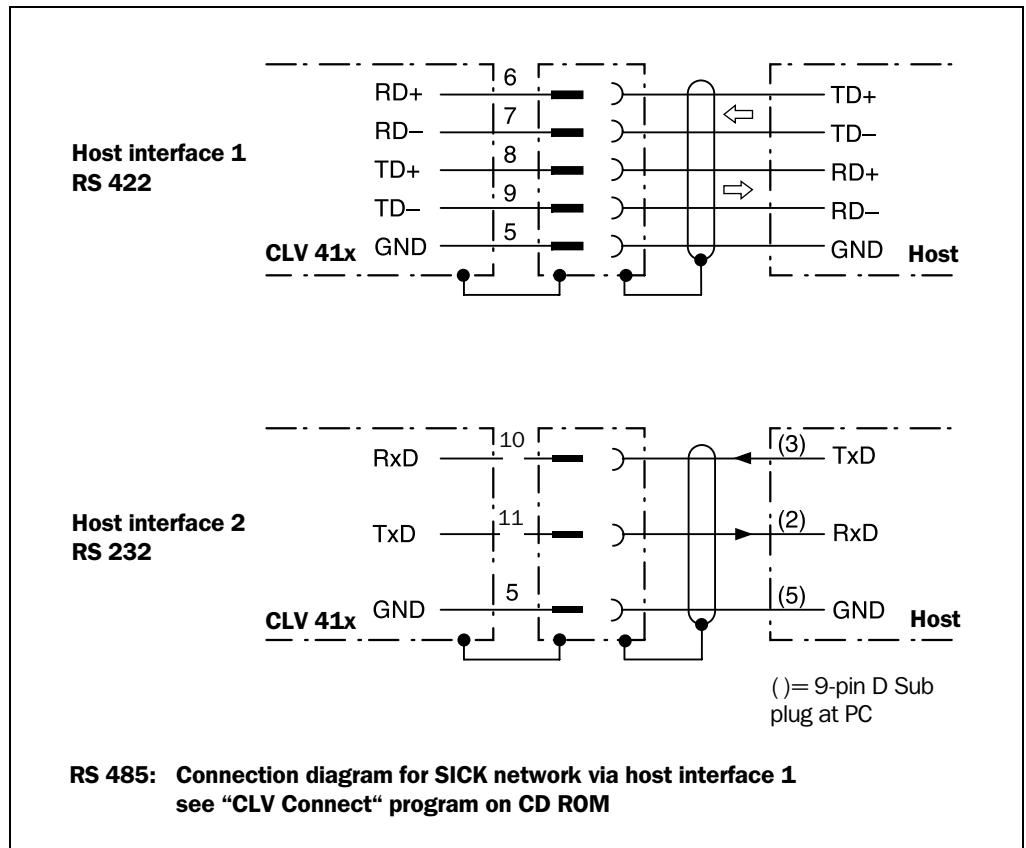

Fig. 5-2: Connections of the host interface



Risk of damage to the interface module

Electronic components in the CLV may be damaged if the host interface is connected incorrectly.

- Connect the host interface as shown in *Fig. 5-2*.
 - Check the connections carefully before you switch on the CLV.
-
- Connect the host interface on the CLV to the host using shielded cables (EMC requirements). Ensure that the maximum cable lengths are not exceeded (*Table 5-2, Page 5-3*).

In the default setting, the CLV communicates with the host via the host interface using the values shown in *Table 5-5, Page 5-6*.

Parameter	Value
Interface model	host interface 1: RS 422/485 host interface 2: RS 232
Data transfer rate	9,600 bd
Data bits	8
Parity	none
Stop bits	1
Protocol	SICK (start character: STX, stop character: ETX, no request for repeat: none, timeout: 50 ms)

Table 5-5: Communication parameters for the host interfaces (default setting)

TIP The communication parameters can be changed, if necessary, on the HOST INTERFACE tab. To do so, change the values under DATA FORMAT and INTERFACE PROTOCOL.



Temporarily activating the default setting of the communication parameters:

Reading the profile bar codes no. 11 (see *Chapter 10.4 Configuring the CLV with profile bar codes, Page 10-16*), the CLV resets temporarily the parameters to the default setting described above if the communication parameters are different. This enables the communication with the PC only via the host interface 2 (RS 232). Reading the profile bar codes no. 12 the CLV returns to the current communication parameters. When starting the communication with the CLV, CLV Setup resets automatically the parameters in the CLV temporarily to the default setting.



For connecting the host interface via the CDB 410 or CDM 410 Connection Module, see the "CDB 410 Connection Module" *Operating Instructions* (order no. 8 010 000, German/English version) respectively the "CDM 410 Connection Module" *Operating Instructions* (order no. 8 010 003, German/English version).

Terminating the RS 422 interface

The interface can be terminated in the CDB 410 or CDM 410 connection module. See *Operating Instructions for the "CDB 410 connection module"* respectively "*CDM 410 connection module*".

5.5.5 Connecting the PC to the host interface 2 (RS 232)

The CLV is operated and configured with the "CLV Setup" program. In order to do so, you must temporarily connect the device to the PC via the host interface 2 (RS 232).

Temporarily disconnect any existing electrical connection between the host interface 2 and the host! We also recommended disconnecting any existing connection between the host interface 1 (RS 422/485) and the host to avoid interferences while parameterizing the CLV.

Set the communication parameters of the host interface 2 temporarily according to *Table 5-5* using CLV Setup. When starting the communication with the CLV, CLV Setup automatically resets the communication parameters in the CLV after a query (see *Fig. 10-5, Page 10-9*).

You can connect the PC to the CLV in two ways, the cable length must not exceed 10 m (32.8 ft):

1. Connecting the PC to the "Aux" plug in CDB 410 or CDM 410 connection module

Fig. 5-2, Page 5-5 shows the connection diagram of the host interface 2.



For connecting the host interface 2 (RS 232) via the CDB 410 or CDM 410 Connection Module as well as setting the required switches and jumpers, see the "CDB 410 Connection Module" *Operating Instructions* (order no. 8 010 000, German/ English version) respectively the "CDM 410 Connection Module" *Operating Instructions* (order no. 8 010 003, German/English version).

1. Switch off the PC and power supply to the SICK connection module.
2. Connect the PC to the internal, 9-pin "Aux" plug of the connection module. Use a 3-core RS 232 data cable (null modem cable) for this purpose, e.g. no. 2 014 054 (RxD and TxD are crossed).
CDB 410 or CDM 410 Connection Module:
Set the switch S 5 (CDB 410) respectively S 7 (CDM 410) to position "RS232->AUX".
– or –
If a non-SICK connection module is used:
Connect the PC as shown in *Fig. 5-2, Page 5-5*.
3. Switch on the PC and power supply to the SICK connection module.
4. Set the communication parameters for the PC and the CLV. (See *Chapter 10.3.3 Starting "CLV Setup", Page 10-8*.)

2. Connecting the PC to the optional programming adapter no. 7 034 552

The programming adapter can be inserted in the connection line between the CLV and the CDB 410 or CDM 410 connection module. The power supply is provided by the connection module. The design of the adapter is shown in *Fig. 5-3*.

The "HOST/PROG" switch either connects the host interface 2 (RS 232) of the CLV to the host (if wired in the connection module) or to the PC. The "CLOCK" push button switch triggers the reading pulse, if the sensor input (Sensor 1) has been configured for reading trigger source in the CLV (default setting: reflector polling). Three LEDs indicate the activity of the switching outputs "Result 1" to "Result 3".

The programming adapter can also be operated independently of the connection module (requires external power supply 12 V DC on "DC" connection).

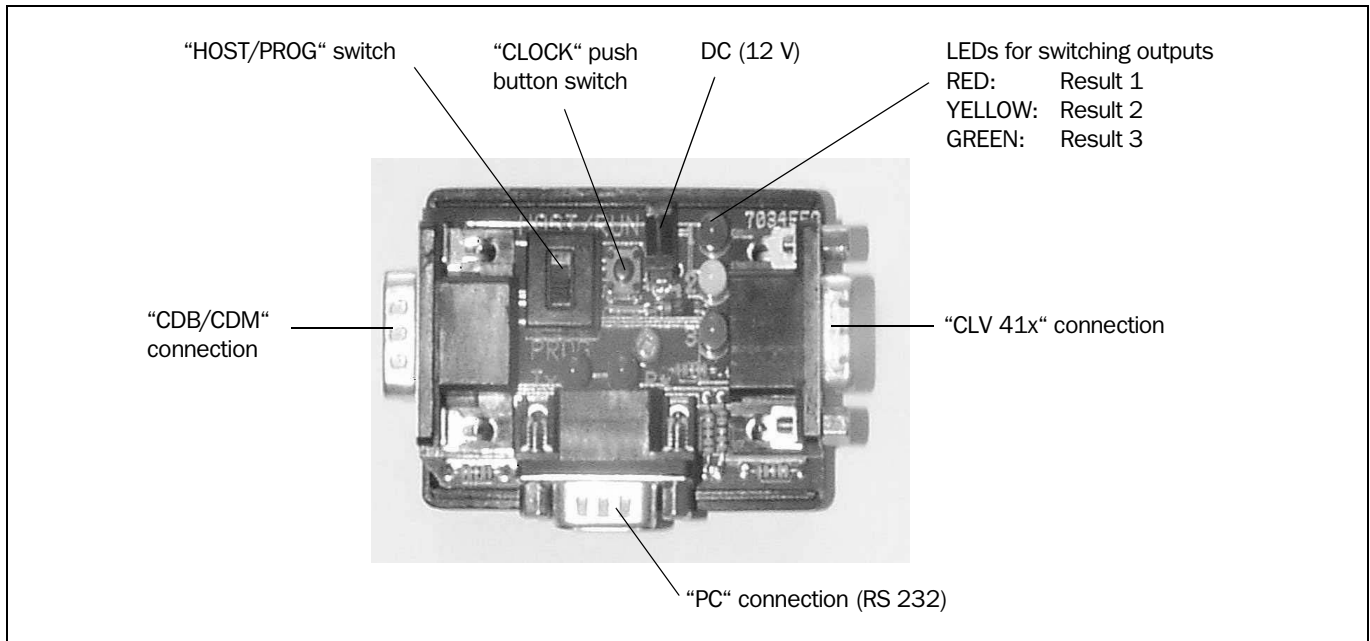

Fig. 5-3: Design of the programming adapter no. 7 034 552

1. Switch off the PC and power supply to the SICK connection module.
2. Connect the 15-pin connector of the CLV to the "CLV 41x" connection (15-pin D-Sub HD socket) of the programming adapter and tight the connector (Fig. 5-4).
3. Connect the programming adapter via the "CDB/CDM" connection (15-pin D-Sub HD-plug) to the corresponding 15-pin socket on the connection module. To do so, use the 15-core cable no. 6 010 075.
4. Connect the COM port of the PC to the "PC" connection (9-pin plug) of the programming adapter. To do so, use a 3-core RS 232 data cable (null modem cable), e. g. no 2 014 054 (RxD and TxD are crossed).
5. Set the sliding switch of the programming adapter to the "PROG" position.
6. Switch on the PC and power supply to the SICK connection module.
7. Set the communication parameters for the PC and the CLV (see Chapter 10.3.3 Starting "CLV Setup", Page 10-8).

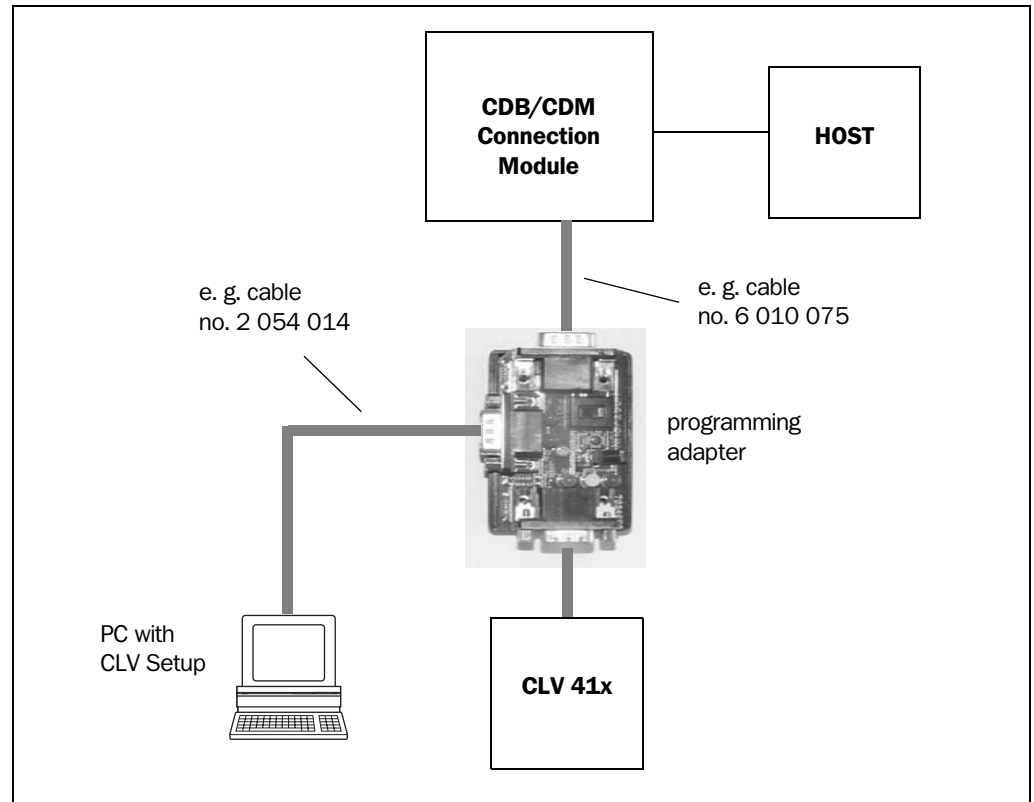



Fig. 5-4: Connection of the host interface 2 (RS 232) via the programming adapter no. 7 034 552

Activating the "Sensor input" pulse mode in the CLV:

1. Select the DEVICE CONFIGURATION tab.
2. Click the READING TRIGGER PARAMETERS button.
The READING TRIGGER PARAMETERS dialog window is then displayed.
3. Choose SENSOR INPUT (ACTIVE HIGH) in the READING TRIGGER SOURCE section.
4. Perform a download to the CLV. This is done by clicking  in the toolbar.
The DOWNLOAD PARAMETER dialog window is displayed.
5. Confirm the dialog window by selecting the PERMANENT save option.
The CLV operates with the "Sensor 1" switching input as an external trigger source.
The reading pulse starts when power is applied (press the "CLOCK" push button switch).

5.5.6 Connecting the "Sensor 1" switching input

In the default setting the CLV is triggered by the continuous reflector polling (see *Chapter 4.4.2 Installing the polling reflector, Page 4-8*). If a reading process has to be triggered in the CLV by an external sensor, the reading pulse sensor must be connected to the "Sensor 1" switching input. *Fig. 5-5* shows the connections for the "Sensor 1" switching input. *Table 5-6* contains the characteristic data for this input.

- Connect the reading pulse sensor as is shown in *Fig. 5-5*.

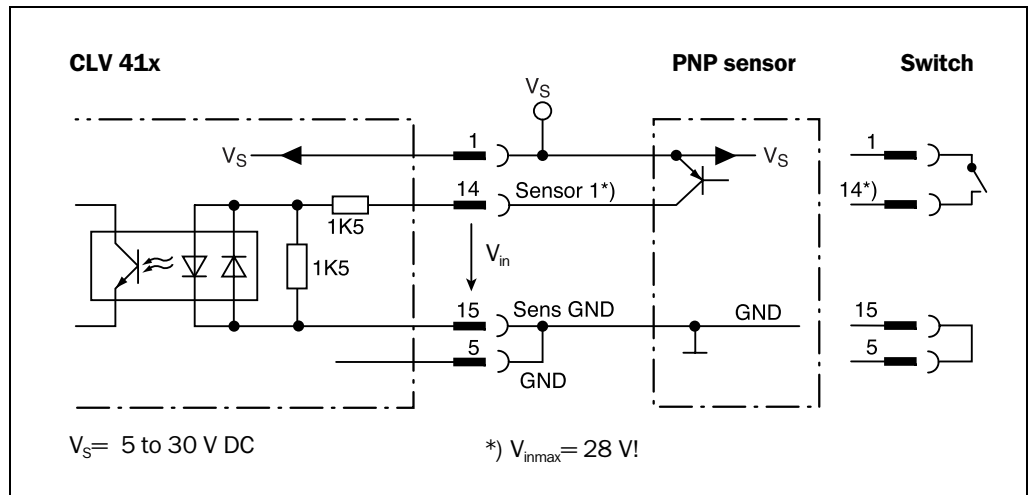



Fig. 5-5: Connections of the "Sensor 1" switching input

Switching mode	Current at the input starts the reading interval on the CLV. (default setting: active high, debouncing: max. 20 ms (standard))
Properties	optodecoupled, non-interchangeable can be connected to PNP output on a sensor
Electrical values	Low: $-1V \leq V_{in} \leq +1 V$ High: $+3 V \leq V_{in} \leq +28 V$ $-0.3 mA \leq I_{in} \leq +0.3 mA$ $+1.4 mA \leq I_{in} \leq +18 mA$

Table 5-6: Characteristic data of the "Sensor 1" switching input

Parameterizing an external sensor as a trigger source:

1. Select the DEVICE CONFIGURATION tab.
2. Click the READING TRIGGER PARAMETERS button.
The READING TRIGGER PARAMETERS dialog window is then displayed.
3. Choose SENSOR INPUT (ACTIVE HIGH) in the READING TRIGGER SOURCE section and activate the dialog box.
4. Perform a download to the CLV. This is done by clicking  in the toolbar.
The DOWNLOAD PARAMETER dialog window is displayed.
5. Confirm the dialog window by selecting the PERMANENT save option.
The CLV operates with the "Sensor 1" switching input as an external trigger source.
The reading pulse starts when power is applied.



Tip

You can change the switching mode (polarity, debouncing, response for first pulse after power-up) of the "Sensor 1" switching input on the DEVICE CONFIGURATION tab in the CLV Setup program.

- Click the READING TRIGGER PARAMETERS button. Edit dialog window.
Download all changes to CLV.

Reduced beboouncing

Reduced beboouncing is available for time-critical applications. The debouncing is dependent of the scanning frequency.

Scanning frequency	Debouncing time
200 Hz	5 to 10 ms
300 Hz	3.3 to 6.7 ms
400 Hz	2.5 to 5 ms
500 Hz	2.0 to 4 ms
600 Hz	1.7 to 3.3 ms
700 Hz	1.4 to 2.9 ms
800 Hz	1.3 to 2.5 ms

Table 5-7: Reduced debouncing of the "Sensor 1" switching input



For connecting the switching input via the CDB 410 or CDM 410 Connection Module, see the "CDB 410 Connection Module" Operating Instructions (order no. 8 010 000, German/English version) respectively the "CDM 410 Connection Module" Operating Instructions (order no. 8 010 003, German/English version).

Note An external pulse is not required for "Percentage Evaluation" and "Read Rate Evaluation" mode.

5.5.7 Connecting the "Sensor 2" switching input

This input is used exclusively to teach in match code 1. The teach-in procedure is an alternative to entering the match code 1 on the keyboard via the CODE COMPARISON field on the DEVICE CONFIGURATION tab in CLV Setup.

In order to teach in the match code, the input is connected briefly to the power supply via a switch. This can also take place in the CDB 410 or CDM 410 connection module.

The characteristic data is identical to that for the "Sensor 1" input (Table 5-6, Page 5-10).

Fig. 5-6 shows the connections of the switching input.

- Connect the sensors as is shown in Fig. 5-6.

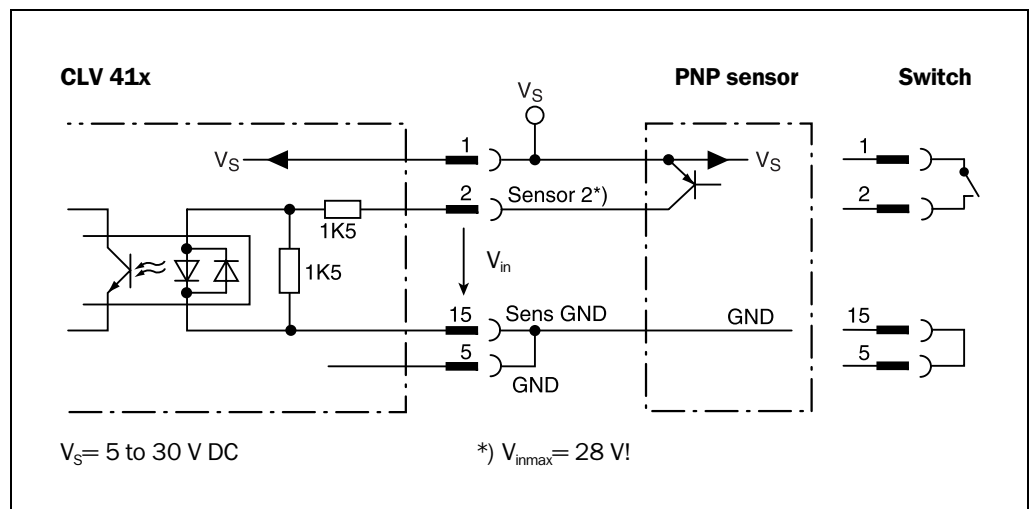

Fig. 5-6: Connections of the "Sensor 2" switching input



For connecting the switching input via the CDB 410 or CDM 410 connection module, see the "CDB 410 Connection Module" Operating Instructions (order no. 8 010 000, German/English version) respectively the "CDM 410 Connection Module" Operating Instructions (order no. 8 010 003, German/English version).

The connections and procedure for teaching in match code 1 are described in Chapter 10.8.1 Triggering the teach-in match code 1 via the "Sensor 2" switching input, Page 10-26.

5.5.8 Connecting the "Result 1" to "Result 3" switching outputs

The three switching outputs can be assigned different functions for outputting result statuses independently of each other. If the assigned event occurs during the reading procedure, the corresponding switching output becomes live at the end of the reading pulse for the selected pulse duration. The pulse length can be set for each output independently of each other.

Fig. 5-7 shows an example of how the "Result 1" switching output can be connected. Table 5-8 describes the characteristic data for the outputs. This data is identical for the three outputs.

- Connect the outputs as shown in Fig. 5-7.

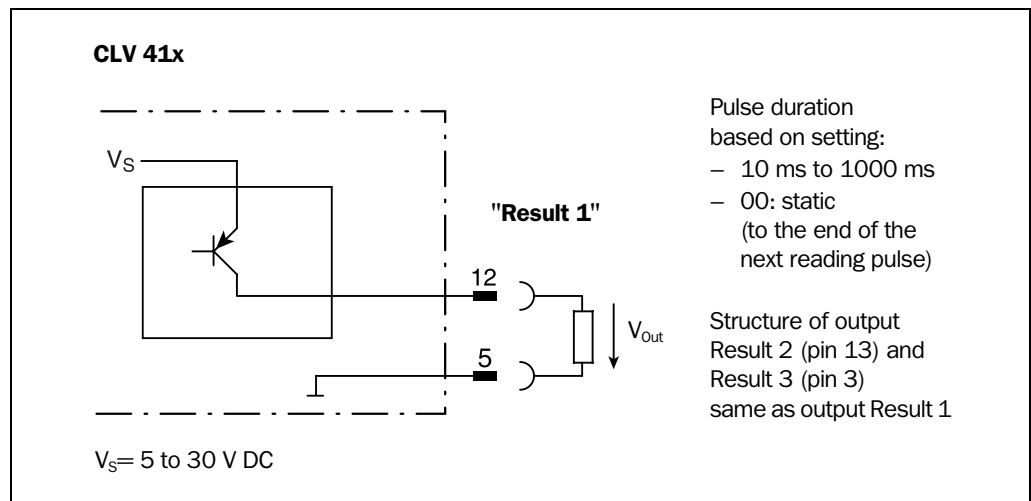

Fig. 5-7: Connections of the "Result 1" switching output



For connecting the switching outputs via the CDB 410 or CDM 410 connection module, see the "CDB 410 Connection Module" Operating Instructions (order no. 8 010 000, German/English version) respectively the "CDM 410 Connection Module" Operating Instructions (order no. 8 010 003, German/English version).

Switching mode	PNP-switching with respect to the power supply V _s
Characteristics	short-circuit-proof + temperature-protected, not electrically isolated from V _s
Function assignment (default setting)	Result 1: "Device Ready" (static), polarity: not inverted Result 2: "Good Read" (100 ms), polarity: not inverted Result 3: "No Read" (100 ms), polarity: not inverted
Electrical values	0 V ≤ V _{out} ≤ V _s Guaranteed: (V _s - 1.5 V) ≤ V _{out} ≤ V _s at I _{out} ≤ 600 mA

Table 5-8: Characteristic data of the "Result 1" to "Result 3" switching outputs

Note If the "Device Ready" function is chosen, the CLV outputs a static pulse in Reading mode. The "Result" LED is independent of the switching outputs and lights on good read in the Reading mode until the end of the next reading pulse.

In "Percentage Evaluation" mode and "Read Rate Evaluation" mode the switching outputs do not become live.



Tip The output function, pulse duration (timer) and polarity of the signals can be changed on the DEVICE CONFIGURATION tab in the CLV Setup program.

- Click the RESULT OUTPUT PARAMETERS button. Edit dialog box. Download all changes to CLV.

Recommendation ➤ To check the switching functions using a high-impedance digital voltmeter, wire a load to the outputs.

This prevents incorrect voltage values/switching statuses from being displayed.

Notes

6 Operation

6.1 Overview of procedure for starting up the CLV



- Start up the CLV with the factory default settings (Quick Start).
With this configuration, the CLV can be operated without being connected to a PC.
- Connect the PC. See *Chapter 5.5.5 Connecting the PC to the host interface 2 (RS 232), Page 5-7 and Chapter 10.3 Installation and operating instructions for the PC-based "CLV Setup" program, Page 10-5.*
- Configure (parameterize) the CLV for the desired application.

6.2 Default settings

Table 6-1, Page 6-2 shows an overview of the factory default settings of the CLV. The default parameters are such that the CLV can be put into operation either straight away or following a few minor adjustments. A PC is not required for startup with the default settings. The default settings of the parameters are stored permanently both in the CLV (ROM) and in the CLV Setup database. They can be loaded into the RAM of the CLV or displayed on the tabs of CLV Setup at any time.



Displaying and printing out complete default settings in CLV Setup:

1. Choose FILE and SAVE AS, and enter a file name in the dialog window that appears.
CLV Setup saves the current settings in a configuration file "*.scl".
2. Click  in the toolbar.
CLV Setup loads the default settings from its internal database and displays them on the tabs.
3. Click  in the toolbar.
The PRINT FILE dialog window is then displayed.
4. If desired, a comment can be entered in the input field for the header of the printout.
Confirm the dialog window with "OK".
The PRINT dialog window for configuring the printer is then displayed.
5. Edit the dialog window accordingly and confirm.

CLV Setup prints out all of the default settings in the form of a table. The header contains the company and user names that were entered during the CLV Setup installation routine.

6.2.1 Default settings: line/raster scanner CLV 41x

Parameter	Default setting
Active code types	Codabar, Code 39, UPC, EAN, 2/5 Interleaved, Code 93, Code 128, EAN 128
Code length	freely assignable (2/5 Interleaved: interval 4 to 50 characters)
Quiet zone	Start/stop ratio, automatic
Min./max. code position	0/100 CP
Multiple read	3
Min./max. no. codes	1
Scanning frequency	500 Hz
Resolution (min. bar width)	0.5 mm (19.7 mil)
Min. reading distance	50 mm (1.97 in)
Reading pulse source	Start: Reflector polling; end: Reflector polling
"Sensor 2" switching input	Teach-in match code
"Sensor 1" switching input	not used, Start and end of reading pulse (level: active high), debouncing 10 to 20 ms
Switching outputs	Not inverted
Status output function	Result 1: "Device Ready" (static), Result 2: "Good read" (100 ms), Result 3: "No read" (100 ms)
Beeper	Status output function: "Good read", volume: low
Arrangement to host	Standalone
Device number	1
Host interfaces (type)	RS 422/485, RS 232
Protocol	NAK ; start character: STX, stop character: ETX
Transfer rate	9,600 bd
Data format	8 data bits; no parity; 1 stop bit
Output format	Good Read: Header: blank; Separator: blank; Terminator: blank; No Read: Separator and error string Error string: NOREAD
Output sorting	in accordance with code position
Output time	Reading result: end of reading pulse Separator: after code
Test string	not activated

Table 6-1: Extract: Default parameter settings of the line/raster scanner CLV 41x

Note If the current communication parameters in the CLV are different to the default setting, CLV Setup automatically resets these parameters temporarily to the default setting when starting the communication with the CLV. Only the host interface 2 (RS 232) remains active. This is useful when the CLV is integrated in a SICK network (RS 485). The CLV need not to be disconnected from the network.

You also can manually set the parameters to the default setting by presenting the profile bar code no. 11 (Host interface: Temporary Default setting ON) from the card no. 8 008 085 during a reading pulse. Use the profile bar codes no. 12 (Host interface: Temporary Default setting OFF) to reset the CLV to the current parameters.

6.3 Quick start

A PC need not be connected when the CLV is operated with the factory default settings. All bar code types are the default code types enabled except Pharmacode.

6.3.1 Starting up the line/raster scanner with the factory default settings

1. Connect the CLV to the SICK CDB 410 or CDM 410 connection module.
2. Switch on the power supply to the CDB 410 or CDM 410.
Once the CLV has started, it outputs a tone to indicate that the self-test was successfully completed. Shortly afterwards, it outputs two tones to indicate that it has assumed reading mode. The "Device Ready" LED lights up. The "Result 1" ("Device Ready") output switches.
3. Align the CLV to the provided white polling reflector (special code) with a reading distance of approx. 300 mm (11.82 in) (not for CLV 414).
4. Start the reading pulse: block the polling reflector, e. g. with a sheet of paper. The "Laser On" LED lights up. The CLV switches the laser diode on and the red scan line appears.
5. Present the bar code pattern from *Fig. 6-1* to the CLV at the reading distance specified in *Table 6-2*.
6. Align the bar code in such a way that the red scan line(s) is (are) almost at a 90° angle to the bars.
7. End the reading pulse: unblock the polling reflector.
The "Laser On" LED is extinguished. The CLV switches off the laser diode. The CLV confirms that the bar code was read successfully by outputting a tone via the beeper. The "Result" LED lights up until the end of the next reading pulse. The "Result 2" switching output (Good Read) becomes live for the duration of 100 ms.

The CLV can now be operated with the factory default settings.

The device can be switched off without the configuration data being lost as no changes have been made to the parameter set.



Fig. 6-1: Bar code pattern (code 39; module width 0.5 mm (19.7 mil); print ratio 2:1)

Device types	Scan procedure	Reading distance
CLV 410	Line/raster scanner	approx. 200 mm (7.88 in)
CLV 412	Line/raster scanner	approx. 200 mm (7.88 in)
CLV 414	Line/raster scanner	—

Table 6-2: Reading distances for module width 0.5 mm (19.7 mil), default settings

6.4 Configuration (parameterizing)

The CLV is configured locally in accordance with the application at hand. The read, evaluation and output characteristics can be parameterized as required. The factory default settings or an application-specific parameter set of the CLV are in effect before changes are made.

The CLV supports four different configuration methods:

- Configuration via the "CLV Setup" program and the CLV Assistant (parameter values are set via the serial interface).
- Configuration via AutoSetup (reading and code configurations for a bar code are adapted automatically via the optical interface (reading window)), see *Chapter 6.4.4 Configuring the CLV with AutoSetup, Page 6-11*.
- Configuration via profile bar codes (parameter values are set via the optical interface (reading window)), see *Chapter 10.4 Configuring the CLV with profile bar codes, Page 10-16*.
- Configuration via command strings (parameter values are set via the serial interface), see *Chapter 10.5 Configuring the CLV with command strings, Page 10-22*.



6.4.1 Configuring CLV with the user interface of CLV Setup

To be able to use "CLV Setup", a PC has to be connected and the program installed on it. The procedure for connecting the PC to the CLV is described in *Chapter 5.5.5 Connecting the PC to the host interface 2 (RS 232), Page 5-7*. Installation and startup of "CLV Setup" and operation of the user interface are described in the appendix. See *Chapter 10.3 Installation and operating instructions for the PC-based "CLV Setup" program, Page 10-5*.

Transferring parameter sets between CLV Setup and the CLV

Upload

When the CLV 41x is being parameterized, CLV Setup runs in the **offline mode**. To be able to modify the current parameter set of the CLV 41x, this first has to be loaded to CLV Setup from the CLV 41x. This procedure is referred to as an **upload** ("Upload from CLV 41x" in the CLV 41x menu or [F3] key) during which CLV Setup always loads a complete copy of the current CLV 41x parameter set. This parameter set remains unchanged until it is overwritten by CLV Setup.

With the help of the **context menu** (right mouse button), only the parameter just edited can be loaded ("Upload parameter") or from version 3.6 all parameters of one tab or one dialog box ("Upload parameters of this view") from the CLV 41x's memory (RAM).

Download

Changes made to the current parameter set in CLV Setup do not take effect until the parameter set has been transferred to the CLV 41x. CLV Setup always sends a copy of the complete parameter set to the CLV 41x, i. e. all of the existing parameter values in the CLV 41x are overwritten. The procedure for transferring and saving the parameter values in the CLV 41x is referred to as a **download** ("Download to CLV 41x" in the CLV 41x menu or [F4] key).

With the help of the **context menu** (right mouse button), only the parameter just edited ("Download parameter") or from version 3.6 all parameters of one tab or one dialog box ("Download parameters of this view") will be **temporarily** loaded into the CLV 41x's memory

(RAM). To finish the parametrization done by this way all parameters must be download again to the CLV with the "Permanent" option.

Loading complete parameter set from the CLV (upload)

- Click  in the toolbar or press [F3] key.
CLV Setup loads the current CLV parameter set from the RAM of the CLV to its database and displays the values on the tabs.
The "Device Ready" LED is extinguished during the upload.

If the "CLV Setup" program does not recognize the parameters transferred during the upload, it outputs a warning. Unknown parameters can be edited on the EXTRAS tab by following the conventions for command strings. When the parameter set is saved, these parameters are also taken into account.

Transferring the complete parameter set to the CLV and saving it (download)

1. Click  in the toolbar or press [F4] key.
The "Device Ready" LED is extinguished.
CLV Setup copies the parameter set to the RAM of the CLV.
The DOWNLOAD PARAMETERS dialog window with the save options is then displayed.
PERMANENT: CLV Setup copies the parameter set to the RAM and to the EEPROM of the CLV.
TEMPORARY: CLV Setup copies the parameter set to the RAM only. The changes are lost when the CLV power supply is switched off.
2. Confirm the dialog box with the desired save option.
The "Device Ready" LED lights up again.

The new parameter set is saved in the CLV, permanently or temporarily dependent on the selected option.

Saving the parameter set in CLV Setup

1. To save the modified parameter set as a new configuration file in CLV Setup, or to overwrite an existing file, choose FILE and SAVE AS.
The SAVE AS dialog window is then displayed.
2. Enter the file name in the dialog window (file extension "*.scl") and confirm the entry.
The new parameter set is now saved in CLV Setup in the subdirectory "data".

6.4.2 Function of tabs in CLV Setup (overview)



Reading Configuration

This tab (and additional dialog windows) are used to set the following:

- Scanning frequency
- Min. module width
- Min. reading distance
- Quiet zone
- Limitation of the evaluation range of the scan line



Device Configuration

This tab (and additional dialog windows) are used to set the following:

- Device number
- Source of the reading pulse

- Output time of the reading result referred to the start of the reading pulse
- Laser timeout
- Physical arrangement for data output via the host interface (standalone, master/slave)
- Functional assignments of the "Result 1" to "Result 3" switching outputs
- Functional assignment and volume of the beeper
- Mode for programming match code 1 (teach-in)
- Code comparison



Code Configuration

This tab (and additional dialog boxes) are used to set the following:

- Activation of evaluation routines for individual code types
- Number of identical reads (multiple reads)
- Minimum and maximum number of bar codes to be read/output
- Activation of comparison of code position for the separation of identical bar codes

Recommendation To enhance the reading reliability with fast applications, only activate those code types and code lengths that are actually relevant.



Host Interface

This tab (and additional dialog boxes) are used to set the following:

- Data format and transfer rate
- Data transfer protocol
- Start and stop characters of the interface protocol



Data Strings

This tab (and additional dialog boxes) are used to set the following:

- Data output format
- Constants and reading diagnosis data in the Header, Separator and Terminator blocks
- Arrangement of the separators in the data string
- Output format for no reads and contents of the error string
- Test string function
- Output sequence and sort criteria for reading more than one bar code per reading pulse
- Activation and structure of format mask



Extras

This tab is used to edit parameters that were not recognized by CLV Setup after an upload.

Note The online "CLV Setup Help" contains a detailed description of the functions of the parameters and their valid entries. See *Chapter 10.3.8 Online help – CLV Setup Help, Page 10-13.*

6.4.3 Parameterization guide

Overview of parameterization procedure

- Parameterize optical reading characteristics of the scanner
- Set up reading pulse
- Parameterize the laser timeout
- Parameterize the evaluation characteristics of the decoder
- Parameterize output characteristics (data, result status)

When the CLV is started up for the first time, the **factory default settings** are in effect. The following parameters must then be set:

a) Parameterizing optical reading characteristics

- Scanning frequency ⇒ READING CONFIGURATION tab ⇒ SCANNING FREQUENCY section
- Minimum bar width ⇒ READING CONFIGURATION tab ⇒ MINIMUM BAR WIDTH section
- Minimum reading distance ⇒ READING CONFIGURATION tab ⇒ MINIMUM READING DISTANCE section
- Rest zone ⇒ READING CONFIGURATION tab ⇒ QUIET ZONE section
- Limitation of evaluation range of the scan line ⇒ READING CONFIGURATION tab ⇒ CODE POSITION READ ZONE section

b) Parameterizing reading pulse source

Action	Settings in CLV Setup
Set up reading pulse: External sensor – or –	⇒ DEVICE CONFIGURATION tab ⇒ READING TRIGGER PARAMETERS button Start: ⇒ READING TRIGGER SOURCE section – Sensor input (Aktiv High) <i>or</i> – Sensor input (Aktiv Low) ⇒ DEBOUNCING section – Standard <i>or</i> – Fast ⇒ FIRST TRIGGER section – Edge <i>or</i> – Level Stop: ⇒ END OF READING INTERVAL section – Generated by trigger source <i>or</i> – Timer: Timeout (referred to the start of the reading pulse) Read result output referred to the start of the reading pulse: ⇒ OUTPUT ON GOOD READ section – End of reading gate <i>or</i> – Immediate Note: Connect the external sensor to the “Sensor 1” switching input.

Table 6-3: Guide: parameterizing reading pulse source and read result output time

Action	Settings in CLV Setup
Set up reading pulse: Command strings – or –	⇨ DEVICE CONFIGURATION tab ⇨ READING TRIGGER PARAMETERS button Start: ⇨ READING TRIGGER SOURCE section – Serial interface Stop: ⇨ END OF READING INTERVAL section – Generated by trigger source <i>or</i> – Timer: Timeout (referred to the start of the reading pulse) Trigger characters: ⇨ SERIAL INTERFACE section – Standard Trigger <i>or</i> – Single characters ⇨ for single characters: start and stop characters Read result output referred to the start of the reading pulse: ⇨ OUTPUT ON GOOD READ section – End of reading gate <i>or</i> – Immediate
Set up reading pulse: Free-running – or –	⇨ DEVICE CONFIGURATION tab ⇨ READING TRIGGER PARAMETERS button Start: ⇨ READING TRIGGER SOURCE section – Free-running with timeout Stop (by trigger source): ⇨ FREE RUNNING section – Timeout Read result output referred to the start of the reading pulse: ⇨ OUTPUT ON GOOD READ section – End of reading gate <i>or</i> – Immediate Note: No laser timeout is available in this pulse mode (the laser diode is not switched off if the reading interval has not be terminated).
Set up reading pulse: Reflector polling – or –	⇨ DEVICE CONFIGURATION tab ⇨ READING TRIGGER PARAMETERS button Start/Stop: ⇨ READING TRIGGER SOURCE section – Reflector polling Read result output referred to the start of the reading pulse: ⇨ OUTPUT ON GOOD READ section – End of reading gate <i>or</i> – Immediate

Table 6-3: Guide: parameterizing reading pulse source and read result output time (contd.)

Action	Settings in CLV Setup
Set up reading pulse: Continuous Read	⇨ DEVICE CONFIGURATION tab ⇨ READING TRIGGER PARAMETERS button Start: ⇨ READING TRIGGER SOURCE section – Continuous Read Stop: ⇨ END OF READING INTERVALL section – Generated by trigger source <i>or</i> – Timer: Timeout (referred to the start of the reading pulse) Note: No laser timeout is available in this pulse mode (the laser diode is not switched off if the reading interval has not be terminated).

Table 6-3: Guide: parameterizing reading pulse source and read result output time (contd.)

c) Parameterizing laser timeout

Action	Settings
1. Select the duration for the laser timeout – or –	⇨ DEVICE CONFIGURATION tab ⇨ READING TRIGGER PARAMETERS button ⇨ LASER TIMEOUT section – Duration
2. Deactivate the laser timeout (laser diode is always active when pulsing, regardless of the pulse duration)	⇨ LASER TIMEOUT section – Click (deactivate) the ACTIVE checkbox

Table 6-4: Guide: parameterizing laser timeout

d) Parameterizing evaluation characteristics

- Activate code types for evaluation ⇨ CODE CONFIGURATION tab ⇨ SYMBOLOGIES section and EDIT buttons
- Activate code comparison ⇨ DEVICE CONFIGURATION tab ⇨ CODE COMPARISON section
- Mode for TEACHING IN match code 1 via the "Sensor 2" switching input ⇨ DEVICE CONFIGURATION tab ⇨ TEACH-IN section

Separation of identical bar codes (same code type/identical contents)

No. of bar codes per object	Line/raster scanner
1. Number n = 1	⇨ CODE CONFIGURATION tab ⇨ CODE POSITION section – Deactivate COMPARE!
2. Number n > 1: – Same code type – Contents different or identical	⇨ CODE POSITION section – Activate COMPARE! ⇨ NUMBER OF CODES section – MINIMUM – MAXIMUM
3. Number n > 1: – Code type different – Contents different or identical	⇨ CODE POSITION section – Deactivate COMPARE! ⇨ NUMBER OF CODES section – MINIMUM – MAXIMUM

Table 6-5: Guide: settings to be made for the evaluation of identical bar codes

e) Parameterizing output characteristics**Result status:**

- Define function of result status output of "Result 1" to "Result 3" switching outputs ⇒ DEVICE CONFIGURATION tab ⇒ RESULT OUTPUT PARAMETERS button
- Define function of result status output and volume of beeper ⇒ DEVICE CONFIGURATION tab ⇒ RESULT OUTPUT section and READING OUTPUT PARAMETERS button

Host interface:

- Arrangement in the data network ⇒ DEVICE CONFIGURATION tab ⇒ ARRANGEMENT section
- Communication parameters ⇒ HOST INTERFACE tab ⇒ DATA FORMAT section
- Protocol ⇒ HOST INTERFACE tab ⇒ INTERFACE PROTOCOL section
- Sort reading result ⇒ DATA STRINGS tab ⇒ OUTPUT SEQUENCE SORT section
- Masking of the reading result ⇒ DATA STRINGS tab ⇒ FORMAT MASK section

Data output string:

- Select contents of Header, Separator and Terminator blocks ⇒ DATA STRINGS tab ⇒ OUTPUT FORMAT section
- Position of separator in data output string ⇒ DATA STRINGS tab ⇒ SEPARATOR section
- Set wrong read format ⇒ DATA STRINGS tab ⇒ WRONG READ FORMAT section and ERROR STRING section
- If necessary, parameterize/activate test string ⇒ DATA STRINGS tab ⇒ TEST STRING section

6.4.4 Configuring the CLV with AutoSetup

AutoSetup enables the reading and code configurations of the CLV to be adapted automatically to the application at hand. The following conditions must be fulfilled with regard to this:

- **one** bar code (code type, code length)
- fixed reading distance
- conveyor belt off (static reading)

The CLV determines the code type, code length and the most favorable scanning rate for the bar code presented in the maximum reading distance of the application. This takes place in Free Running mode. Once AutoSetup has been completed successfully, the CLV copies the parameter values determined to its parameter set. **All other code types and code lengths are then disabled.** If AutoSetup was not completed successfully, the parameter set is not changed. The CLV does not read a Pharmacode or any EAN/UPC types in AutoSetup. It does not respond to an external reading pulse.

AutoSetup can be activated in three different ways in the CLV:

- via the user interface of CLV Setup
- by presenting profile bar code no. 10 (on the card supplied no. 8 008 085) to the optical interface (reading window). See *Chapter 10.4.1 Activating AutoSetup with a profile bar code, Page 10-16.*
- via a command string (via the serial interface). See *Chapter 10.5 Configuring the CLV with command strings, Page 10-22.*

While AutoSetup is running, the CLV does not output any read result. Once AutoSetup has been completed, no error messages are output for diagnosed malfunctions in the event of a no read. Connecting a PC and using CLV Setup allows you to check the reading quality of the taught-in bar code in the Percentage Evaluation mode.

Explanation AutoSetup procedure

1. Starting at 800 Hz, the CLV decreases its scanning frequency to 200 Hz in steps of 100 Hz. It evaluates the reading quality of 100 scans for each step.
2. The CLV performs verification reads ± 50 Hz around the scanning frequency with the highest reading quality.
3. It then copies the optimum scanning frequency, the code type and code length to its parameter set.



Activating AutoSetup via the user interface of CLV Setup



In CLV Setup, AutoSetup can be started via the View menu, via the terminal emulator or as an executable device function (interactively).

Preparing AutoSetup:

1. Switch on the power supply of the CDB 410 or CDM 410 connection module (of the CLV).
After the CLV has started, it outputs a tone to indicate that the self-test was successful. After a short while, it outputs two consecutive tones to indicate that it has switched to reading mode. The "Device Ready" LED lights up.
2. Upload the current parameter set from the CLV with CLV Setup (the parameter set initially contains the factory default settings).
CLV Setup displays the current values on the tabs.

3. AutoSetup overwrites important values in the current parameter set of the CLV. Save the existing parameter set as a configuration file "*.scl" in CLV Setup before you change the parameter settings. See *Chapter 6.4.1 Configuring CLV with the user interface of CLV Setup, Page 6-4*.

Performing AutoSetup:

1. Click  in the toolbar.
The terminal emulator is launched. The CLV is in reading mode.
2. Present the application-specific bar code to the CLV at the **maximum** reading distance for the application. Note the limits of the CLV here. See *reading field diagrams in Chapter 10.2 Specification diagrams, Page 10-1*.
To prevent surface reflections, rotate the bar code towards the CLV approximately 15° away from the vertical axis. See *Fig. 4-7, Page 4-5*.
3. Click AUTO SETUP under DEVICE MODE.
The CLV cancels reading mode. The "Device Ready" LED is extinguished.
The CLV then starts AutoSetup.
The red scan line appears when the "Laser On" LED lights up.
4. The CLV confirms that AutoSetup has been completed successfully by outputting two consecutive tones via the beeper and briefly activating the "Result" LED. To begin with, it only overwrites the appropriate parameter values in the RAM.
The CLV returns to reading mode. The "Device Ready" LED lights up. The CLV only evaluates the presented code type and length the next time a bar code is read.
5. Perform an upload from the CLV. This is done by clicking  in the toolbar.
CLV loads the current parameter set from the RAM of the CLV and displays the new values in the tabs.
6. Perform a download to the CLV. This is done by clicking  in the toolbar.
The DOWNLOAD PARAMETER dialog box is displayed.
7. Confirm the dialog box by selecting the PERMANENT save option.
The CLV saves the changes made to the parameter set permanently in the EEPROM.
8. Close the terminal emulator.

AutoSetup canceled by the CLV in the event of a no read:

If the CLV was not able to execute AutoSetup successfully after approx. 35 s, it cancels the search mode after the last decrease made to the parameter values by outputting three consecutive tones via the beeper. Then the CLV starts AutoSetup again with each wrong read.

- Close the terminal emulator and open it again.
The CLV returns to reading mode.
The "Device Ready" LED lights up.
The current parameter set in the CLV does not change.

Note If AutoSetup has been interactively started via DEVICE FUNCTION, the CLV automatically cancels the procedure after a few seconds.

Terminating AutoSetup prematurely:

- To abort AutoSetup when once started via the terminal emulator proceed as describe above.

Running AutoSetup again:

1. Click READING MODE under DEVICE MODE.
The CLV switches to reading mode.
2. Click AUTO SETUP under DEVICE MODE again.
The CLV then starts AutoSetup.
3. If AutoSetup is unsuccessful again, check whether the CLV is able to read the bar code correctly (reading distance, tilt, more than one bar code in the reading field).

Checking parameter values stored in the CLV (after parameters are saved):

1. Switch the power supply of the connection module (of the CLV) off and on again.
2. Perform an upload from the CLV. This is done by clicking  in the toolbar.
3. Check the values in the READING CONFIGURATION and CODE CONFIGURATION tabs.
Only one code type may be active on the CODE CONFIGURATION tab.

Note The CLV does not enter a real value in the parameter set for the parameters "Minimum Bar Width" and "Minimum Reading Distance", as it is not able to determine any absolute dimensions. This is why the value displayed on the READING CONFIGURATION tab does not match the actual conditions.

Checking the stored read and code configurations:

Once AutoSetup has been completed successfully, check the CLV settings as follows:

1. Click  in the toolbar.
The Terminal Emulator is launched. The CLV is in reading mode.
2. Click PERCENT EVALUATION under DEVICE MODE.
The dialog box for the distance configuration is then displayed.
3. Confirm the dialog box with "OK".
The CLV starts the percentage evaluation and displays the reading quality of each set of 100 scans continuously. See *Chapter 6.5.2 Percentage evaluation, Page 6-17*.
4. Present the application-specific bar code at the distance taught in (at the minimum and maximum reading distance if the bar code in the application is in a variable reading range).
5. Check the reading quality in the terminal emulator. This should be between 70 and 100 %.

6.5 Operating modes and outputting the reading result

The following CLV operating modes/functions can be selected in CLV Setup:

Standard operating mode

- Reading mode

For startup

- Percentage evaluation
- Read Rate Evaluation

For adapting device to application

- AutoSetup (automatic adaptation to reading conditions):
See Chapter 6.4.4 *Configuring the CLV with AutoSetup*, Page 6-11.
- Profile programming (configuration):
See Chapter 10.4.2 *Profile programming*, Page 10-18.
- Parameterization (configuration):
See Chapter 6.4.1 *Configuring CLV with the user interface of CLV Setup*, Page 6-4.
- Teach-in match code 1/activate match code comparison with "Sensor 2" switching input.
See Chapter 10.8.1 *Triggering the teach-in match code 1 via the "Sensor 2" switching input*, Page 10-26.

For monitoring purposes/correcting faults

- Displaying and editing operating data
- Self-test

6.5.1 Reading mode (standard operating mode)

The CLV performs a self-test after it has been switched on. It is then set to the reading mode and confirms this by outputting two consecutive tones via the beeper. In the default setting, the reflector polling is the trigger source of the internal reading interval. The reading result is output by the CLV at the end of the reading interval via both host interfaces.

Depending on the configuration, the switching outputs "Result 1" to "Result 3" become live for the predefined pulse length when defined events occur during the reading process (e. g. Good Read).

The reading result of the host interface 2 (RS 232) can be displayed in the CLV Setup terminal emulator. The structure of the represented reading result corresponds to the data output format defined on the DATA STRINGS tab.

The READING MODE can be called up by choosing VIEW in the menu bar or via the terminal emulator.



Displaying the reading result in the terminal emulator:

1. Click  in the toolbar.
The TERMINAL EMULATOR dialog box is then displayed.
2. Click READING MODE under DEVICE MODE.
3. Align the CLV to the provided white polling reflector (special code) with a reading distance of approx. 300 mm (11.82 in) (not for CLV 414).
4. Start the reading pulse: block the polling reflector, e. g. with a sheet of paper.
The "Laser On" LED lights up. The CLV switches the laser diode on and the red scan line appears.

5. Present the bar code pattern from *Fig. 6-1, Page 6-3* to the CLV at the reading distance specified in *Table 6-2, Page 6-3*.
6. End the reading pulse: unblock the polling reflector.

The "Laser On" LED is extinguished. The CLV switches off the laser diode.

The CLV outputs a tone via the beeper to indicate that the reading result is displayed in the window of the Terminal Emulator. The "Result" LED lights up until the end of the next reading pulse.

Fig. 6-2 shows two examples of reading result output: "good read" and "no read". The reading result comprises the data contents of the bar code(s) and the reading diagnosis data/constants parameterized to be output. In the default setting, the "Header", "Separator" and "Terminator" blocks do not contain any reading diagnosis data or constants. The CLV only reads and outputs here one bar code. The reading result for "Good Read" only comprises the data content of the bar code, the reading result for "No Read" comprises the parameterized wrong read format. *Chapter 6.5.2 Percentage evaluation, Page 6-17* explains the structure and function of a part of the reading diagnosis data.

Note The CLV only outputs several bar codes in the reading result if the parameterized minimum and maximum number of bar codes is > 1, and several bar codes have been presented. The number of bar codes to be read/output for each reading interval can be selected on the CODE CONFIGURATION tab in the NUMBER OF CODES group.

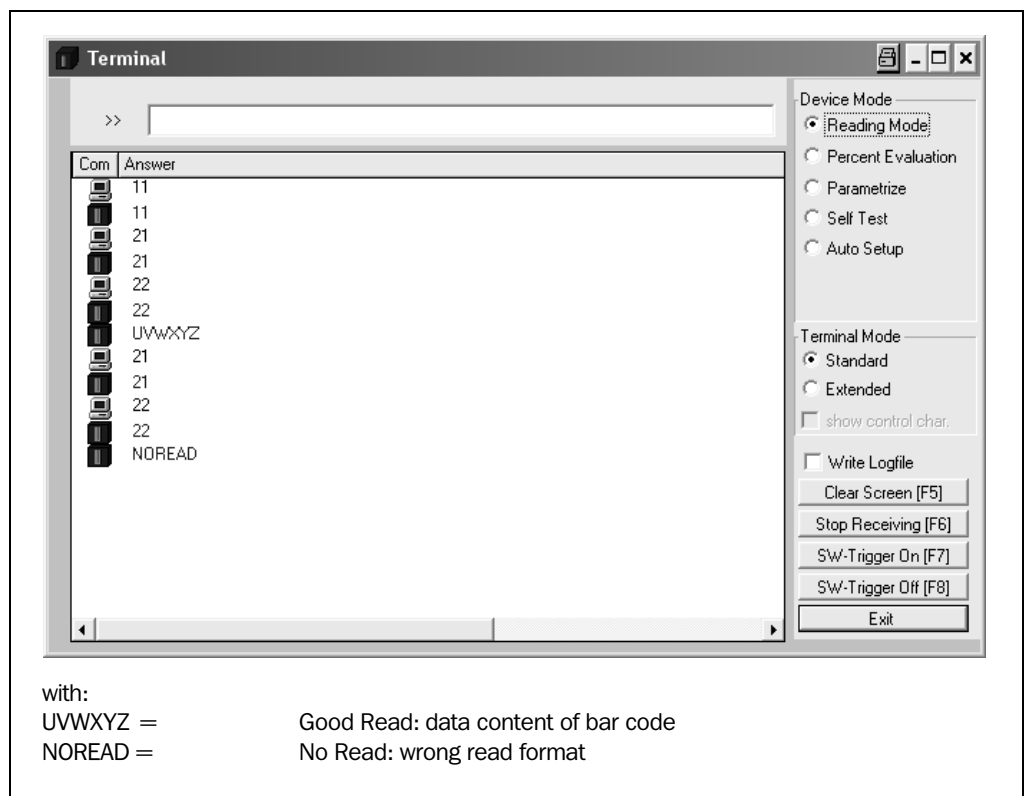



Fig. 6-2: CLV Setup: Reading mode: output of the reading result in the terminal emulator

Note In the reading mode, the CLV does not output the contents of the polling reflector.

**Tip**

The structure of the data output string can be configured via the DATA STRINGS tab:

- Up to 10 elements, consisting of constants (control characters, letters, digits) and/or reading diagnosis data, can be entered in the "Header", "Separator" and "Terminator" blocks.
 - The position of the "Separator" block can be chosen before or after the code.
1. Select the DATA STRINGS tab.
 2. Click in the HEADER input field.
The dialog window EDIT PARAMETER: TFH is displayed.
 3. Click the desired constants or placeholders for the reading diagnosis data.
The selected elements appear in the text box at the top of the dialog window in the sequence in which they were selected.
 4. Confirm the dialog box with "OK".
 5. Repeat this procedure for the "Separator" and "Terminator" blocks.
 6. Perform a download to the CLV. This is done by clicking  in the toolbar.
The DOWNLOAD PARAMETER dialog box is displayed.
 7. Confirm the dialog box by selecting the PERMANENT save option.
The CLV outputs the selected elements in the data output string of the host interface with the next reading result.

Triggering the reading pulse via the terminal emulator:

In the default setting, the reflector polling is the trigger source of the reading pulse. For test purposes the reading pulse can also be triggered directly via the terminal emulator of CLV Setup. To do so, a different trigger source must be selected temporarily in the CLV.

1. Choose the DEVICE CONFIGURATION tab.
2. Click the READING TRIGGER PARAMETERS button.
The READING TRIGGER PARAMETERS dialog box is then displayed.
3. Click SERIAL INTERFACE under READING TRIGGER SOURCE.
4. Confirm the dialog box with "OK".
5. Perform a download to the CLV.
To do so, click the SERIAL INTERFACE option again with the right mouse button and choose DOWNLOAD PARAMETER in the context menu.
CLV Setup copies the parameter to the CLV temporarily.
The serial interface has been activated as the trigger source of the reading pulse and is ready to receive appropriate commands (until the CLV is switched off).
6. Click  in the toolbar.
The TERMINAL EMULATOR dialog box is then displayed.
The CLV is in reading mode.
7. Click the SW-TRIGGER ON button or press [F7] key.
CLV Setup sends a start command to the CLV.
The "Laser On" LED lights up. The red scan line then appears.
8. Present the bar code sample from *Fig. 6-1, Page 6-3*.
9. Click the SW-TRIGGER OFF button or press [F8] key.
CLV Setup sends a stop command to the CLV.
The "Laser On" LED is extinguished. The CLV switches off the laser diode.
The CLV outputs a tone via the beeper to indicate that the reading result is displayed in the terminal emulator. The "Result" LED lights up until the end of the next reading pulse.

6.5.2 Percentage evaluation



In the Percentage evaluation mode, the reading quality of bar codes which enter the reading field of the CLV and are not moved (conveyor off) is assessed. This mode allows to check the correct alignment of the CLV to the bar code.

The CLV performs 100 scans in "Free Running" mode and evaluates the reading quality. It outputs the reading result continuously every 2 s together with a fixed set of reading diagnosis data. The reading results can be displayed in the terminal emulator of CLV Setup. The switching outputs "Result 1" to "Result 3" and the beeper do not become live in the Percentage evaluation mode.

The Percentage evaluation mode can be called up by choosing VIEW in the menu bar or via the terminal emulator.

1. Click  in the toolbar.
The terminal emulator window is then displayed. The CLV is in reading mode.
2. Click PERCENT EVALUATION under DEVICE MODE.
The "Device Ready" LED is extinguished. The CLV initiates the percentage evaluation and outputs the reading results continuously. An example is shown in Fig. 6-3.
3. Present the bar code pattern from Fig. 6-1, Page 6-3 and monitor the reading results in the terminal emulator window.

The behavior of the "Result" LED also indicates the reading quality:

- LED is extinguished if reading quality is < 30 %
- LED flashes twice per second if the reading quality is 30 % to 70 %
- LED flashes five times per second if the reading quality is 70 % to 90 %
- LED is lit continuously if the reading quality is > 90 %

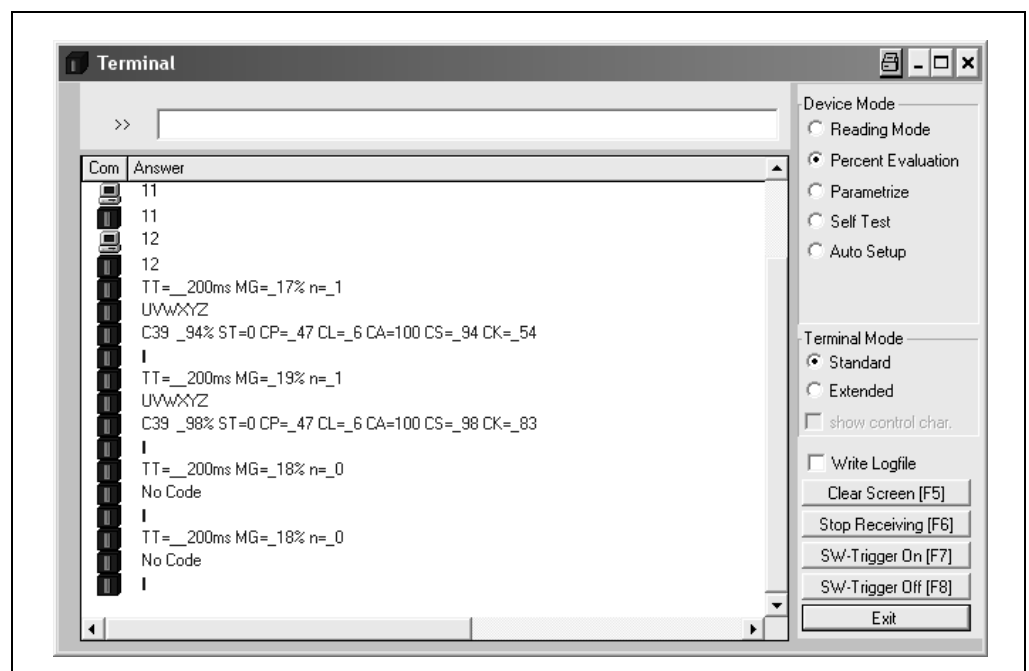

Fig. 6-3: CLV Setup: Percentage evaluation mode: output of the reading result in the terminal emulator

Fig. 6-4, Page 6-18 explains the structure and function of the reading diagnosis data for Good Read, and Fig. 6-5, Page 6-18 for No Read.

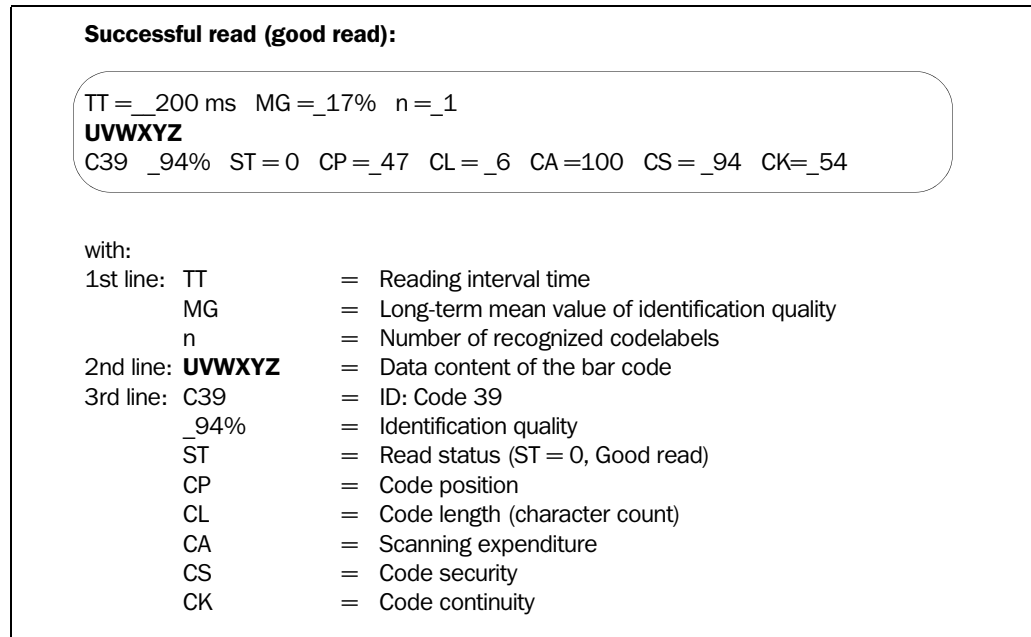

Fig. 6-4: Percentage evaluation mode: structure of the reading result for "good read"

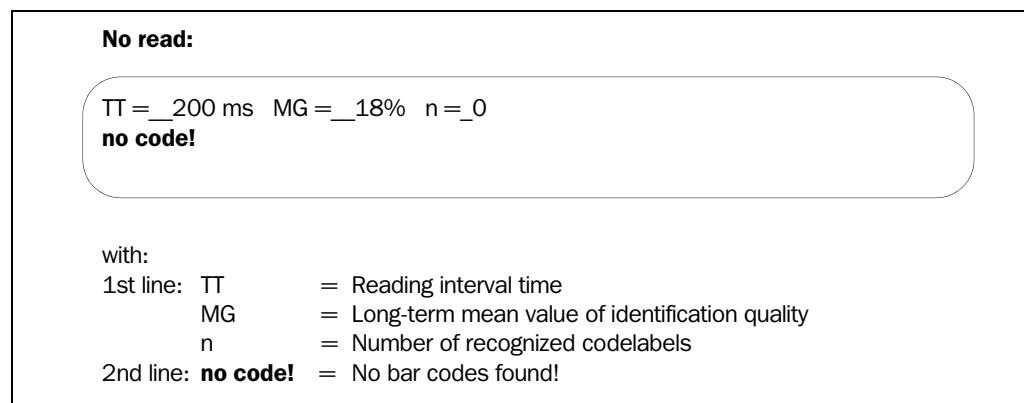

Fig. 6-5: Percentage evaluation mode: structure of the reading result for "no read"

Note Profile bar codes read by the CLV during the percentage evaluation do not cause any changes to be made to the parameter set and do not, therefore, affect the reading process either.

The match code cannot be programmed (taught in) in the percentage evaluation mode. This is entered on the DEVICE CONFIGURATION tab. The match code 1 can also be programmed using the teach-in method.

The CLV outputs the data contents of the uncovered polling reflector with the identifier "REPO" in the percentage evaluation mode.

6.5.3 Read Rate Evaluation

This operating mode complies with the Percentage Evaluation mode (see *Chapter 6.5.2 Percentage evaluation, Page 6-17*). In distinction from the Percentage Evaluation the CLV does not output any reading results via the host interfaces. It signals the current reading rate with the behaviour of the "Result" LED (flashing frequency) and additionally with a corresponding tone sequence of the beeper (*Table 6-6*).

Reading rate	LED flashing frequency	Tone sequence
< 30 %	off	1 Hz
30 to 70 %	2 Hz	2 Hz
70 to 90 %	5 Hz	5 Hz
90 % to 100 %	on	continuous tone

Table 6-6: Read Rate Evaluation: Tone sequence of the beeper as a function of the reading rate

The "Device Ready" LED and the switching outputs "Result 1" to "Result 3" do not become live in Read Rate Evaluation.



The Read Rate Evaluation can be called up via the terminal emulator as followed:

1. Click  in the toolbar.
The terminal emulator window is then displayed. The CLV is in reading mode.
2. Enter 17 in the command line ① and press the [Return] key (*Fig. 6-6*).
The "Device Ready" LED is extinguished. The CLV initiates the Read Rate Evaluation and indicates the reading quality results continuously by signals of the beeper.
3. Present the bar code pattern from *Fig. 6-1, Page 6-3* and listen to the tone sequence of the beeper. A continuous tone signals the optimum of reading rate and the correct alignment of the CLV to the bar code.
4. Enter 11 in the command line to return to Reading mode and press the [Return] key.
5. Close the terminal emulator.

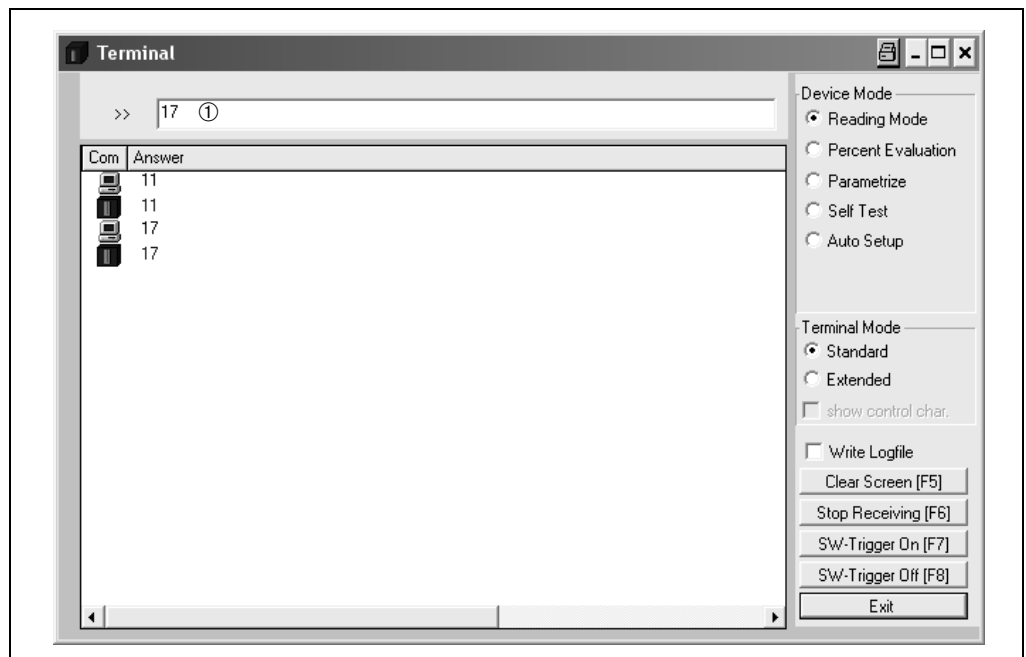

Fig. 6-6: CLV Setup: Calling up the "Read Rate Evaluation" mode in the terminal emulator

6.5.4 Displaying and editing operating data

This function enables statistical operating data, which the CLV maintains in the form of counters during the reading procedure, to be displayed and reset. The CLV does not output a reading result in this mode.



1. Click  in the toolbar.
The CLV cancels reading mode. The "Device Ready" LED is extinguished. The OPERATING DATA dialog box appears (Fig. 6-7).
2. After checking/resetting the desired counters, click "OK" to confirm any changes made. The CLV returns to reading mode. The "Device Ready" LED lights up.

Fig. 6-7: CLV Setup: "Operating Data" dialog box

6.5.5 Self-test

After the CLV has been switched on, it performs a self-test before it is initialized with the parameter set. The test can be called up explicitly at any time via CLV Setup. During the self-test, the CLV checks that its hardware components are functioning correctly. A final message provides information on the test result.

The CLV does not output a reading result during the test routine.



1. Click  in the toolbar.
The terminal emulator window is then displayed. The CLV is in reading mode.
2. Click SELF TEST under DEVICE MODE.
The "Device Ready" LED is extinguished. The CLV cancels the reading mode and starts the test routine.
After a few seconds, the CLV outputs the encoded test result in the form of a code number (Fig. 6-8).
3. To return to the reading mode, activate READING MODE or close the terminal emulator. The CLV returns to reading mode. The "Device Ready" LED lights up.

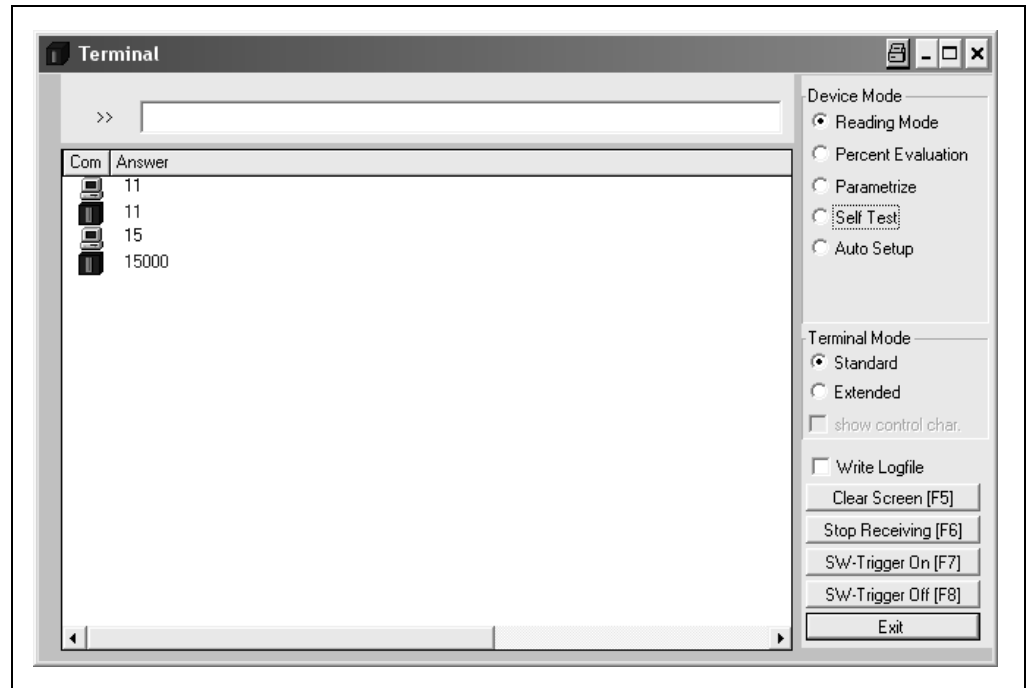

Fig. 6-8: CLV Setup: displaying the self-test result in the terminal emulator

The code number "15000" means that the self-test was completed successfully and that no faults were diagnosed.

6.5.6 Performing device functions of the CLV in the dialog box

CLV Setup enables a number of CLV functions to be executed interactively. CLV Setup prompts the user to carry out specific actions and provides information on the progress of the function being executed.

The following functions are available:

- AutoSetup
- Match code Teach-in
- Activate factory defaults in device
- In the menu bar, select the desired function from CLV 41x, DEVICE FUNCTIONS.

– or –

Press the [F2] key.

The DEVICE FUNCTIONS dialog box is then displayed.

Select the desired function from the EXECUTE menu. CLV Setup starts the function and, where appropriate, prompts the user to carry out the necessary action.

Fig. 6-9, Page 6-22 shows an example of the dialog box that appears after AutoSetup has been started.

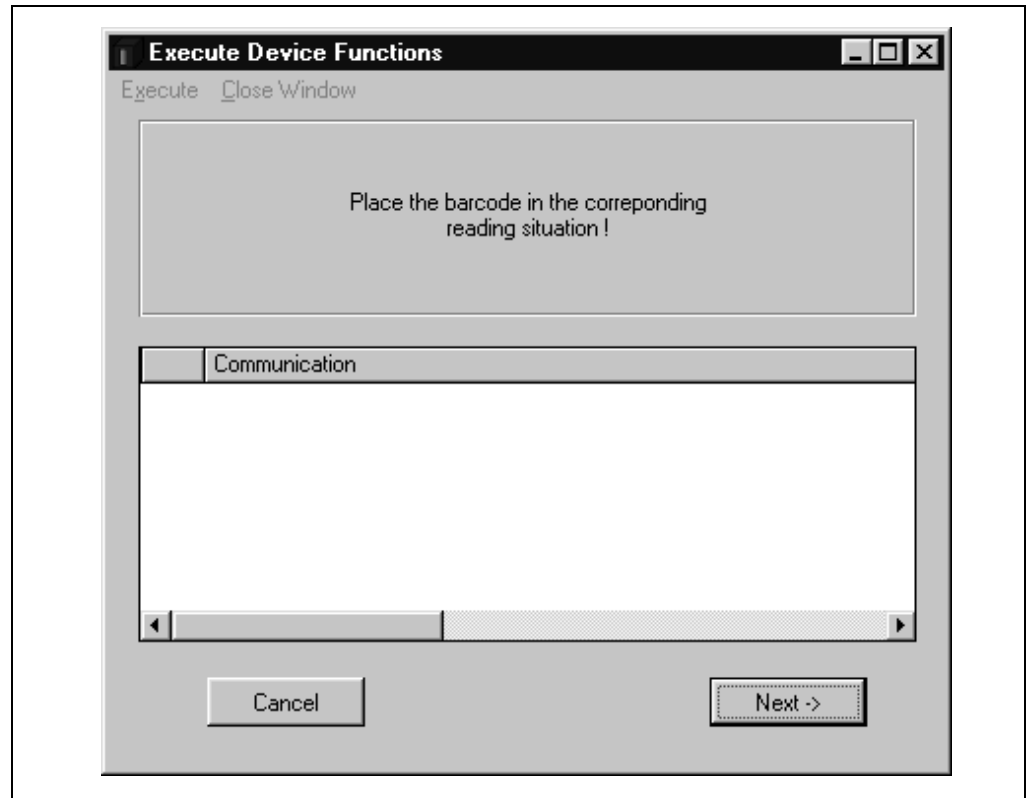

Fig. 6-9: CLV Setup: dialog box for AutoSetup execution

6.6 CLV messages

The CLV outputs coded error messages (3 digits, 15xxx) only in the Self-test mode. In Reading mode the CLV outputs the ST reading error status in the "Separator" block of the reading result (if the error status has been enabled via the DATA STRINGS tab. Disabled in default setting). ST= 3 indicates a device fault. For further values of the ST error status see *Table 8-1, Page 8-2*.

6.7 Switching off the CLV

1. If the parameter set was modified in CLV Setup or was only stored temporarily in CLV 41x via a download ("Temporary" option or via context menu (right mouse button)), the parameter set must be stored permanently in the CLV 41x by choosing the PERMANENT storage option.
2. Save parameter set as a "*.scl" configuration file in CLV Setup.
3. Switch off the power supply of the CDB 410 or CDM 410 or pull the plug of the CLV from the connection module.

The last parameter set stored permanently in the CLV remains valid.

We recommend that you print out the configuration file in order to archive the parameter set.

1. Click  in the toolbar.
The PRINT FILE dialog box is then displayed.
2. Enter a comment in the input field in order to assign the printout to the CLV.
Confirm the dialog box with "OK".
The PRINT dialog box for configuring the printer is then displayed.
3. Edit the dialog box accordingly and confirm.
CLV Setup prints out the current configuration file in the form of a table.

7 Maintenance

7.1 Cleaning during operation

To ensure optimum reading performance, the reading window of the CLV must be clean at all times.

For this reason, we recommend that you check the reading window at regular intervals, particularly if the device is operated under extreme conditions (dust, abrasion, humidity, finger prints).



Laser radiation can seriously damage your eyesight

The CLV uses a class 2 red-light laser. Looking directly at the laser beam can seriously damage the retina in your eyes.

- As with sunlight, never look directly into the laser beam.
- Switch off the device while it is being cleaned.
- Never look directly into the reading window while the device is in operation.



Damage to the reading window

The reading window is made of glass. Scratches and streaks on the window will reduce the reading performance.

- Use a mild, non-scouring detergent.
- Never use scratching or scouring motions to clean the reading window.

Cleaning reading window

- Clean the reading window at regular intervals with a mild, non-scouring detergent, e.g. an antistatic glass cleaning fluid. *Fig. 7-1* shows the areas that require cleaning.

Use a soft, lint-free cloth.

- If necessary, clean the LEDs on the rear of the device.

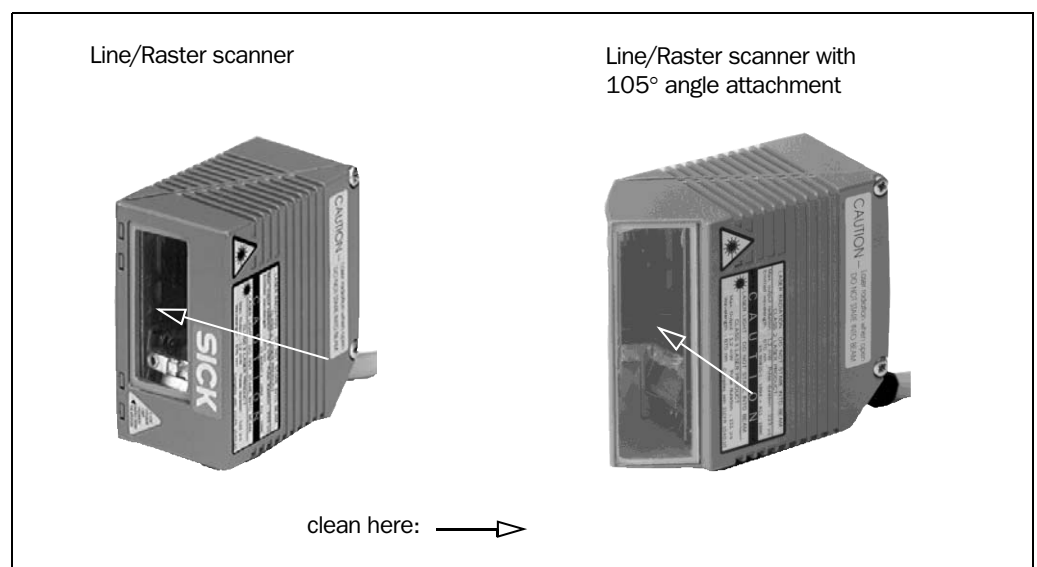

Fig. 7-1: Cleaning the reading window

Note Don't open the device. The producer warranty will be forfeited if the device is opened.

Cleaning other optical surfaces:

- If an external reading pulse generator with a sensor (e.g. photoelectric reflex switch) is used, make sure to clean the relevant optical surfaces (Fig. 7-2). Contamination on these surfaces can cause switching errors.
- If the reading pulse is generated by reflector polling, make sure to clean the surface of the reflector.

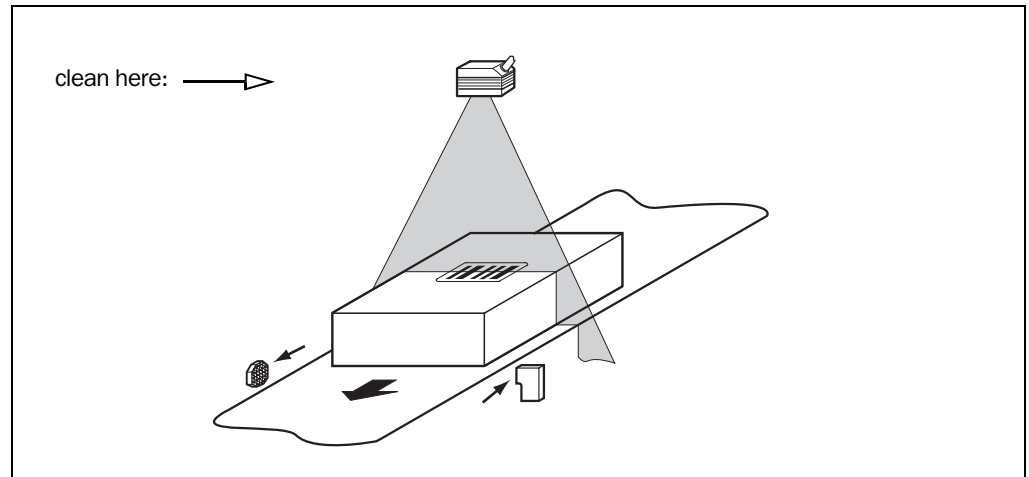

Fig. 7-2: Cleaning the external optical sensor (reading pulse generator)

7.2 Maintenance

The CLV does not require any maintenance except the described cleaning measures. Its self-monitoring function ensures fault-free operation over long periods of time.

The CLV outputs detected device faults by sending the error status ST= 3 via the host interface (if the error status has been enabled via the DATA STRINGS tab. Disabled in default setting). See also *Chapter 8.4 Troubleshooting, Page 8-3*.

7.3 Disposal

Irreparable devices or devices that are no longer required are to be disposed of in an environmentally-friendly manner:

1. Always observe the applicable national waste disposal regulations.
2. Remove the CLV housing.
3. Remove the electronic modules and the connection cable.
4. Remove the glass panel from the reading window and send it to be recycled.
5. Send the chassis and cover (zinc die-cast) to be recycled.
6. Send the electronic modules and connection cable for disposal as special waste.

At present, SICK AG does not accept any unusable or irreparable devices.

8 Troubleshooting

8.1 Overview of errors and malfunctions which could occur

8.1.1 Installation errors

- CLV aligned incorrectly with the object carrying the bar code (e.g. masking)
- Polling reflector or reading pulse sensor positioned incorrectly

8.1.2 Electrical connection errors

- Interfaces on the CLV connected incorrectly (wiring error in CDB 410 or CDM 410)

8.1.3 Parameterization errors

- Functions not adjusted to local conditions, e.g. communication parameters on the host interface are set incorrectly
- Technical limits of the device exceeded, e.g. relationship between the scanning frequency and the reading distance

8.1.4 Malfunctions during operation

- Laser timeout for laser diode elapsed
- Device error (hardware/software)

8.2 Monitoring errors and malfunctions

The CLV is self-monitoring:

- After the power supply has been switched on, the CLV automatically carries out a self-test, in which it checks important hardware components, before it is initialized (loading of parameter set and initializing of device functions). The self-test can be repeated at any time by canceling reading mode. *For calling up, see Chapter 6.5.5 Self-test, Page 6-20.*
- If the CLV detects an error during the self-test or at any other time, it outputs the error status ST= 3 via the host interface. Prerequisite: the error status is enabled for transmission. By default, transfer is blocked.
- While it is in operation, the CLV constantly monitors the laser diode and speed of the polygon mirror wheel. In addition, a watchdog circuit responds to error statuses.
- A timer automatically deactivates the laser diode 10 minutes (default setting) after a continuous reading pulse is initiated in reading mode with switching input pulse modes "Sensor Input" and "Serial Interface". In this case, the CLV outputs three consecutive tones via the beeper. The reading pulse must be terminated by resetting the pulse signal. The laser diode is activated again by the next reading pulse.

8.3 Error messages

The CLV does not output any error messages except the ST error status.

Value	Meaning	Possible cause	Remedy
0	"Good read"	–	not applicable
1	Incorrect check digit	The check digit calculated by the CLV during the reading process does not match that printed in the bar code.	Check whether the check digits in the bar code which were generated by the print process are correct.
2	No bar code of the enabled code type found according to the evaluation criteria	<ul style="list-style-type: none"> No bar code in the CLV's reading range during the reading pulse. Code type/length in the CLV not enabled for decoding. Reading window obstructed/dirty. 	<ul style="list-style-type: none"> Synchronize the pulse of the CLV with the entry of a bar code into the reading area. Correct the code configuration parameters. Check the reading window.
3	Device fault	Device fault	Call up the self-test! See <i>Chapter 6.5.5 Self-test, Page 6-20</i> . If result \neq 15000: Contact the SICK Service department.
5	Required number of successful multiple reads for the bar code not reached	<ul style="list-style-type: none"> Conveyor speed of the object is too high. Scanning frequency is too low. Ladder-type arrangement for bar code relative to the conveyor direction: code height (bar length) too poor. Print quality too poor. 	<ul style="list-style-type: none"> Check the conveyor speed. Adjust the scanning frequency. Check the code height. Check the print quality.
6	Master: Number of slave reading results does not match the parameterized number of slaves	<ul style="list-style-type: none"> The parameterized number of slaves does not match the actual number of slaves available. Timeout for the master is selected too short. Data connection between slaves and/or the master has been interrupted. 	<ul style="list-style-type: none"> Check the entered number of slaves. Check the master timeout setting. Check the cables between the slaves and the master.
9	The OUTPUT FILTER function is also activated for the code comparison. The CLV has detected valid bar codes. However, these do not match the active match code(s)	The scanned object does not have a bar code that matches the specified match code.	not applicable
A	The CHECK MAX. NUMBER OF CODES function is active. The number of valid bar codes detected by the CLV in reading mode exceeds that specified under NUMBER OF CODES: MAXIMUM. It repeatedly outputs the defined error string until the number specified under NUMBER OF CODES: MINIMUM is reached.	One object in a set of objects with a constant number of bar codes, for example, contains more bar codes than defined in the application.	This message is used to indicate errors on the objects (e.g. check whether objects are homogeneous: mix with incorrect objects).
D	The "Code 32" evaluation option is activated for Code 39. The CLV is attempting to interpret 6-digit C39 bar codes as C32 bar codes (output as 9-digit decimal values).	The read 6-digit bar code is not a C32 bar code. The CLV outputs the defined error string instead.	not applicable

Table 8-1: Meaning of the ST error status in the reading result

8.4 Troubleshooting

The following are required for troubleshooting purposes using the tables below:

- Tools
- A tape measure (up to 1 m (39.4 in))
- A digital measuring device (ammeter/voltmeter)
- A PC running "CLV Setup"
- A 3-core RS 232 data cable (null modem cable), pins 2 and 3 crossed, e.g. no. 2 014 054

8.4.1 General malfunction: CLV not ready

Malfunction	Possible cause	Remedy
The "Device Ready" LED is not lit. The "Device Ready" switching output (default setting: "Good read") is not outputting a pulse.	<p>After switching on the power supply (5 to 30 V DC):</p> <ul style="list-style-type: none"> • CLV not supplied with operating voltage • The CLV has diagnosed a device error in the self-test <p>During operation:</p> <ul style="list-style-type: none"> • The CLV is not in "reading" mode • The CLV has deactivated the laser diode 10 min (default setting) after the start of the current reading pulse (pulse mode: sensor input/serial interface) 	<ul style="list-style-type: none"> • Check wiring (power connector fitted securely to the CDB 410 or CDM 410 connection module). Measure voltage at pin 1 and pin 5. • Switch the CLV off and on again. Does the LED light up? If not, contact the SICK Service department. • Return to reading mode using the CLV Setup program See <i>Chapter 6.5.1 Reading mode (standard operating mode)</i>, Page 6-14. • Terminate reading pulse. Check the reading pulse function. Generate new pulse or parameterize new laser timeout duration using the CLV Setup user interface. See <i>Chapter 6.4.3 Parameterization guide</i>, Page 6-7.

Table 8-2: Troubleshooting: restoring operation (reading mode)

8.4.2 Malfunctions in reading mode: reading pulse errors

Prerequisite The "Device Ready" LED lights up. If not, see remedy in *Table 8-2, Page 8-3*.

Malfunction	Possible cause	Remedy
<p>1. Pulse mode: Reflector polling</p> <p>The CLV cannot be pulsed:</p> <ul style="list-style-type: none"> – the "Laser On" LED flickers but does not light up constantly – the red scan line is very faint 	<ul style="list-style-type: none"> • Incorrect reading pulse source parameterized on the CLV • Incorrect reading distance (polling reflector) • Incorrect reflector type used • Incorrect pulsing sequence (reflector is not blocked to start the reading interval on the CLV) 	<ul style="list-style-type: none"> • In the CLV Setup program: Select the tab DEVICE CONFIGURATION and click the READING TRIGGER PARAMETERS button. READING TRIGGER SOURCE group: reflector polling selected? • Check: reading distance of reflector in specified reading range? • Check reflector type, <i>Table 4-2, Page 4-9</i>. • Check sequence: Read: 1. Block reflector, 2. Read bar code, 3. Unblock reflector.
<p>2. Pulse mode: sensor input (external sensor).</p> <p>The CLV cannot be pulsed:</p> <ul style="list-style-type: none"> – the "Laser On" LED does not light up – the red scan line does not appear 	<ul style="list-style-type: none"> • Incorrect reading pulse source parameterized on the CLV • Polarity of switching input inverted • Sensor not connected or connected to incorrect switching input • If sensor supplied by CLV: sensor not connected to ground potential • Photoelectric switch not aligned with the reflector (photoelectric switch/inductive sensor not dampened) 	<ul style="list-style-type: none"> • In the CLV Setup program: Select the tab DEVICE CONFIGURATION and click the READING TRIGGER PARAMETERS button. READING TRIGGER SOURCE group: sensor input selected? • Active high: reading pulse starts when power applied. • Connect sensor to "Sensor 1" switching input. Check sensor wiring (<i>Fig. 5-5, Page 5-10</i>). Measure output signal on sensor. • Insert jumper between pin 5 and pin 15. (CDB 410: switch S 3, CDM 410: switch S 6) • Align sensor. Check functioning.
<p>3. Pulse mode: Serial Interface</p> <p>The CLV cannot be pulsed:</p> <ul style="list-style-type: none"> – the "Laser On" LED does not light up – the red scan line does not appear 	<ul style="list-style-type: none"> • Incorrect reading pulse source parameterized on the CLV • The CLV is not receiving any command string to start the reading interval on the data interface 	<ul style="list-style-type: none"> • In the CLV Setup program: Select the tab DEVICE CONFIGURATION and click the READING TRIGGER PARAMETERS button. In the READING TRIGGER SOURCE group: is serial interface selected? Group SERIAL INTERFACE: is trigger type correct? • Check data connection to host. In the CLV Setup program: Select the HOST INTERFACE tab. In DATA FORMAT group: are the correct interface type (hardware) and data format selected? Group: INTERFACE PROTOCOL: are the correct start and stop characters selected?
<p>4. CLV does not respond to an external signal that ends the reading pulse (sensor input, reflector polling, serial interface)</p>	<p>Incorrect end of reading pulse parameterized on the CLV</p>	<p>In the CLV Setup program: Check by choosing the DEVICE CONFIGURATION tab, click the READING TRIGGER PARAMETERS button. END OF READING INTERVAL group: is "Generated by Trigger Source" selected?</p>

Table 8-3: Troubleshooting: reading pulse errors in reading mode

8.4.3 Malfunctions in reading mode: result output errors

- Check whether the "Device Ready" LED illuminates.
If the LED does not illuminate, follow *Table 8-2, Page 8-3*.
For the following, the number of bar codes to be read is 1.

Malfunction	Possible cause	Remedy
<p>1. The "Result" LED (Good read) does not light up at the end of the reading pulse.</p> <ul style="list-style-type: none"> – The "Result 2" switching output (default setting: "Good read") is not outputting a pulse – The CLV outputs the status ST = 2 in the reading result on the host interface (if ST is enabled for the separator; this is not selected in the default setting) 	<ul style="list-style-type: none"> • Read not successful, since there was no bar code in the reading field during the reading pulse • Code comparison: the code read does not match the defined match code • Reading configuration for the presented bar code in CLV parameterized incorrectly • Scan line positioned incorrectly • Evaluation range of the scan line is limited improperly (CP values) • Bar code presented at incorrect reading distance • The bar code is tilted excessively with respect to the scan line • The reading angles at which the bar code appears to the CLV are too large • Bar code is in total reflection zone 	<ul style="list-style-type: none"> • Synchronize reading with an object in the reading field. <i>See Table 8-3, Page 8-4.</i> • not applicable • In the CLV Setup program: Check by choosing the READING CONFIGURATION tab, READING PARAMETERS section. Are the min. reading distance and min. bar width values correct? • Align CLV. Is bar code at center of scan line? In the CLV Setup program: check reading quality. Choose PERCENTAGE EVALUATION. <i>See Chapter 6.5.2 Percentage evaluation, Page 6-17.</i> • In the CLV Setup program: Check by choosing the READING CONFIGURATION tab, CODE POSITION group: are the min. and max. code position values correct? • Check: reading distance of bar code in specified reading range? • Align bar code accordingly. • In the CLV Setup program: Start PERCENTAGE EVALUATION. <i>See Chapter 6.5.2 Percentage evaluation, Page 6-17.</i> Monitor reading quality (reading quality >70 %!). Realign CLV if necessary. • Optimize CLV alignment (scan line should strike the bar code at an skew of approx. 15°). In the CLV Setup program: check reading quality. Start PERCENTAGE EVALUATION. <i>See Chapter 6.5.2 Percentage evaluation, Page 6-17.</i>

Table 8-4: Troubleshooting: result output errors in reading mode

Malfunction	Possible cause	Remedy
<p>1. The "Result" LED does not light up at the end of the reading pulse. (default setting: "Good read")</p> <p>– continued –</p>	<ul style="list-style-type: none"> Evaluation criteria for bar code incorrect Bar code quality not adequate 	<ul style="list-style-type: none"> In the CLV Setup program: Choose the CODE CONFIGURATION tab, SYMBOLOGIES group. Enable all code types (except Pharmacode), set code lengths to FREE. Download temporarily to CLV! Start PERCENTAGE EVALUATION. Code type and length are displayed in the reading result. Enable recorded code type in the SYMBOLOGIES group and disable all other types. Enter the code length under FIXED on the code type tab. Download to CLV! Check: Are sufficient blank zones present? Is the print contrast adequate? Are the specified print tolerances exceeded? In the CLV Setup program: Check by choosing READING CONFIGURATION tab, QUIET ZONE group. Is "Start/Stop" selected? Perform test read with a reference code in good condition.
<p>2. The CLV is not transferring any reading results to the host.</p>	<ul style="list-style-type: none"> Reading pulse is not functioning correctly Wiring fault in data connection Voltage level incorrect Host interface in CLV parameterized incorrectly 	<ul style="list-style-type: none"> See Table 8-3, Page 8-4. Check wiring as shown in Fig. 5-2, Page 5-5. Measure voltages. In the CLV Setup program: Check by choosing HOST INTERFACE tab, DATA FORMAT group. Is the correct data format selected? Check settings in INTERFACE PROTOCOL group.
<p>3. The CLV transfers the status ST = 3 to the host in the reading result (if ST is enabled for the separator; this is not selected by default).</p>	<p>The CLV has diagnosed a device error in the self-test.</p>	<p>Switch the CLV off and on again. Does the "Device Ready" LED light up? If not, contact the SICK Service department.</p>
<p>4. The data content of the bar code output by the CLV is incorrect or incomplete.</p>	<ul style="list-style-type: none"> The data format on the host interface is parameterized incorrectly in the CLV The CLV suppresses the last character in the bar code. 	<ul style="list-style-type: none"> In the CLV Setup program: Select the HOST INTERFACE tab, DATA FORMAT group. Are the values correct? In the CLV Setup program: Select the CODE CONFIGURATION tab. Click the SYMBOLOGY PARAMETERS button. Choose the tab for the relevant code. Is Transmit Check Digit activated? Change if necessary. Download to CLV!

Table 8-4: Troubleshooting: result output errors in reading mode (contd.)

8.4.4 Malfunctions in reading mode: errors when outputting the result status

Prerequisite The "Device Ready" LED lights up. If not, see remedy in *Table 8-2, Page 8-3*.

Malfunction	Possible cause	Remedy
1. The switching outputs – "Result 2" (default setting: "Good Read") – "Result 3" (default setting: "No read") are not outputting any pulses.	<ul style="list-style-type: none"> The event of the assigned function for outputting the result status does not occur during the reading process Incorrect switching mode parameterized in CLV 	<ul style="list-style-type: none"> not applicable In the CLV Setup program: Check by choosing the DEVICE CONFIGURATION tab. Click the RESULT OUTPUT PARAMETERS button. Are the outputs set to "Invert Output"? Change if necessary. Download to CLV!
2. The beeper is not confirming the output of the reading result (default setting: "Good read").	Beeper deactivated	In the CLV Setup program: Check by choosing tab DEVICE CONFIGURATION, group RESULT OUTPUT/BEEPER VOLUME: is "Low" or "High" selected?

Table 8-5: Troubleshooting: errors in the result status output in reading mode

8.4.5 Malfunctions: configuration errors (parameterization)

Prerequisite The "Device Ready" LED lights up. If not, see remedy in *Table 8-2, Page 8-3*.

Malfunction	Possible cause	Remedy
1. AutoSetup: The CLV does not read the presented, application-specific bar code (no confirmation from beeper)	<ul style="list-style-type: none"> CLV not in "AutoSetup" mode If AutoSetup is started with profile bar code no. 10: wait time of 5 s after power-up has been exceeded Bar code presented at incorrect reading distance Bar code is in total reflection zone Bar code quality not adequate 	<ul style="list-style-type: none"> Check: Does the "Device Ready" LED light up? If so, the CLV is in "reading" mode again. In CLV Setup program: Restart AUTOSETUP from the VIEW pull-down menu. Switch the CLV off and on again. Present profile bar code no. 10 within 5 s. Then present the application-specific bar code. Check: Is the reading distance of the bar code within the specified reading area? Optimize bar code alignment (scan line should strike the bar code at an angle of approx. 15°). See <i>Malfunction 1, Table 8-4, Page 8-5</i>
2. Profile programming: CLV does not read the presented profile bar code (no confirmation from beeper)	<ul style="list-style-type: none"> Wait time of 5 s after power-up has been exceeded Wait time of 10 s after the first profile bar code was presented has been exceeded In reading mode: CLV not pulsed 	<ul style="list-style-type: none"> Switch the CLV off and on again. Present profile bar code within 5 s. Once the first profile bar code has been read successfully, present the next bar code within 10 s, etc. Clock the CLV accordingly and present the first profile bar code. Present the next bar code within 10 s, etc.

Table 8-6: Troubleshooting: configuration errors (parameterization)

8.5 SICK Support

If the error status ST = 3 occurs repeatedly or if you cannot correct an error using the above measures, the CLV may be defective. The CLV contains no user-serviceable parts.

Please contact our local SICK office or subsidiary:

- The telephone numbers and email addresses are listed on the *back page* of this manual.
For postal addresses see also **www.sick.com**.
- Do not send the device to the SICK service without first contacting us.

CLV 41x bar code scanner

9 Technical data

9.1 Data sheet CLV 41x bar code scanner (fixed focus)

Type	CLV 410 (Standard)	CLV 412 (High Density)	CLV 414 (Short Range)
Line scanner	CLV 410-0010	CLV 412-0010	CLV 414-0010
Raster scanner	CLV 410-1010	CLV 412-1010	CLV 414-1010
Line scanner with 105° angle attachment	CLV 410-2010	CLV 412-2010	CLV 414-2010
Raster scanner with 105° angle attachment	CLV 410-3010	CLV 412-3010	CLV 414-3010
Focus	Fixed focus		
Reading window	Line/raster scanner: front Line/Raster scanner with angle attachment: side (angle of emergence 105°)		
Laser diode (wavelength)	red light ($\lambda = 670 \text{ nm}$)		
MTBF of laser diode	20,000 h		
Laser class of device	Class 2 (pursuant to DIN EN 60825-1), shutoff of laser diode after 10 min ¹⁾		
Useable aperture angle	max. 60° (front reading window)/max. 50° (side reading window)		
Scanning/decoding frequency	200 to 800 Hz		
Resolution	0.2 to 1.0 mm (7.8 to 39.4 mil)	0.1 to 0.2 mm (3.94 to 7.8 mil)	0.2 to 0.5 mm (7.8 to 19.7 mil)
Reading range	50 to 380 mm (1.97 to 14.97 in)	45 to 92 mm (1.77 to 3.62 in)	42 to 97 mm (1.65 to 3.82 in)
Raster height	15 mm (0.6 in) (8 lines) at a reading distance of 200 mm (7.9 in) (front reading window)		
Bar code print contrast (PCS)	≥ 60 %		
Immunity to ambient light	2,000 lx (on bar code)		
No. of bar codes per scan	1 to 3		
No. of bar codes per reading interval ²⁾	1 to 10 (autodiscriminating)		
Bar code types	Code 39, Code 128, Code 93, Codabar, EAN, EAN 128, UPC, 2/5 Interleaved, Pharmacode		
Bar code length	max. 50 characters (max. 100 characters across all bar codes per reading interval)		
Print ratio	2:1 to 3:1		
No. of multiple reads	1 to 99		
Visual indicators	4 x LEDs		
Acoustic indicator	Beeper, can be deactivated and assigned to a function for result status indication		
Reading pulse	Reflector polling/"Sensor 1" switching input/ser. interface/free running/Continuous Read		
"Host" data interfaces	RS 232 and RS 422/485, variable data output format		
Data transfer rate	300 to 57,600 bd		
Protocols	SICK Standard, SICK Network		
Physical configurations	Standalone, SICK Network (bus), Daisy Chain (pass-through or master/slave)		
Switching inputs	2 ("Sensor 1", "Sensor 2") – optodecoupled, $V_{\text{imax}} = 30 \text{ V}$, non-interchangeable, can be connected to PNP outputs – "Sensor 1" (reading pulse): max. internal delay 20 ms/reduced max 2.5 ms – "Sensor 2" (teach-in matchcode): max. internal delay 20 ms		
1) default setting, in Reading mode with the "Sensor 1 switching input" and "Serial interface" pulse types			
2) Reading interval: time window generated internally for evaluating the code			

Table 9-1: Technical specifications of the CLV 41x (line/raster scanner)

Type	CLV 410 (Standard)	CLV 412 (High Density)	CLV 414 (Short Range)
Switching outputs	3 ("Result 1" to "Result 3") – PNP, $I_{o,max} = 600$ mA, short-circuit-proof, variable pulse duration (stat., 10 to 1000 ms) – Variable output function for result status		
Electrical connection	15-pin D Sub HD connector, cable length 0.9 m (35.5 in)		
Operating voltage ³⁾ /power consumption	5 to 30 V DC pursuant to IEC 364-4-41 (VDE 0100 (Teil 410))/max. 3 W		
Housing	Zinc die-cast, does not represent a problem in paint shops		
Enclosure rating/Protection class	IP 65 (to DIN 40 050)/Class 3 (to VDE 0106/IEC 1010-1)		
EMC/vibration/shock tested	pursuant to EN 61000-6-3, EN 61000-6-2/pursuant to IEC 68-2-6 Test FC/pursuant to IEC 68-2-27 Test EA		
Weight	250 g (8.8 oz) with connecting cable (with side 105° angle attachment : approx. 320 g (11.3 oz))		
Operating/storage temperature	0 to +40 °C/–20 to +70 °C (+32 to 104 °F/–4 to + 158 °F)		
Max. rel. humidity	90 %, non condensing		
Color	SICK blue (RAL 5012)		
3) The CLV 41x is UL certificated when a class 2 power supply according to UL 1310 is used.			

Table 9-1: Technical specifications of the CLV 41x (line/raster scanner) (contd.)

9.2 CLV dimensional drawings

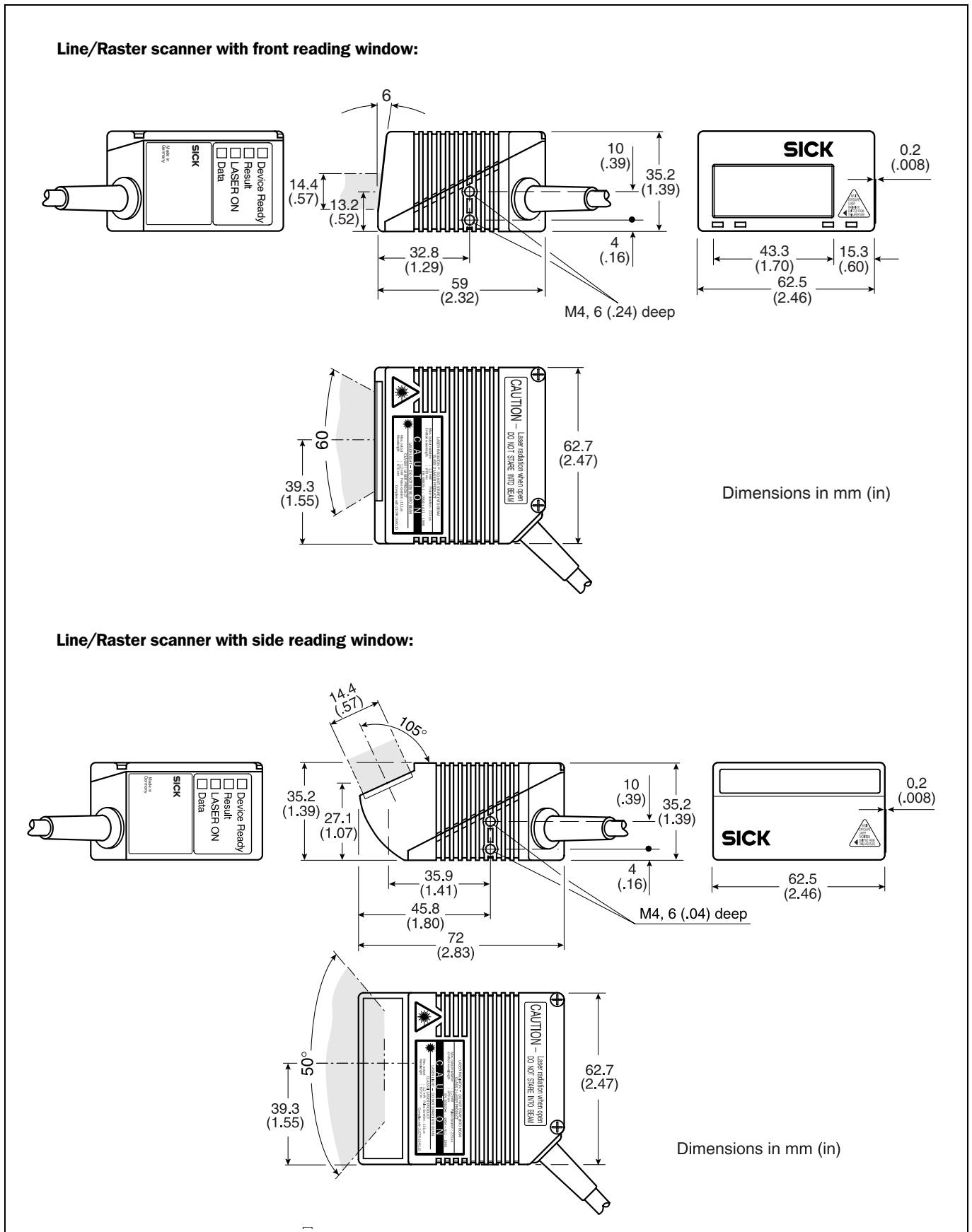

Fig. 9-1: Dimensions of the CLV 41x line/raster scanner

Notes

10 Appendix

10.1 Overview

The Appendix contains the following additional information:

- Specification diagrams
 - Line/Raster scanner
 - Line/Raster scanner with 105° angle attachment
- Installation and operating instructions for the PC-based "CLV Setup" program
- Configuring the CLV with profile bar codes
- Configuring the CLV with commands
- Calculating parameter values for setting the CLV
- Tables
- Special applications and procedures
- Replacing a CLV (copying the parameter set)
- Accessories
- Dimensional drawings of the accessories
- Supplementary documentation
- Glossary
- Copy of the EC Declaration of Conformity
- Index
- Scannable sample bar codes

10.2 Specification diagrams

10.2.1 Reading conditions for all diagrams

Test code	Code 39/ITF
Print ratio	2:1
Print contrast	> 90 %
Tilt	±10°
Ambient light	< 2,000 lx
Good read rate	> 75 %

Table 10-1: Reading conditions for specification diagrams

Raster scanner:

raster height 15 mm (0.59 in) at 200 mm (7.88 in) reading distance

Note **Line/raster scanner with 105° angle attachment:**

the whole reading range shifts by 15 mm (0.59 in) towards the reading window.

The maximum aperture angle is 50°.

10.2.2 Reading field diagram for CLV 410 line/raster scanner (standard)

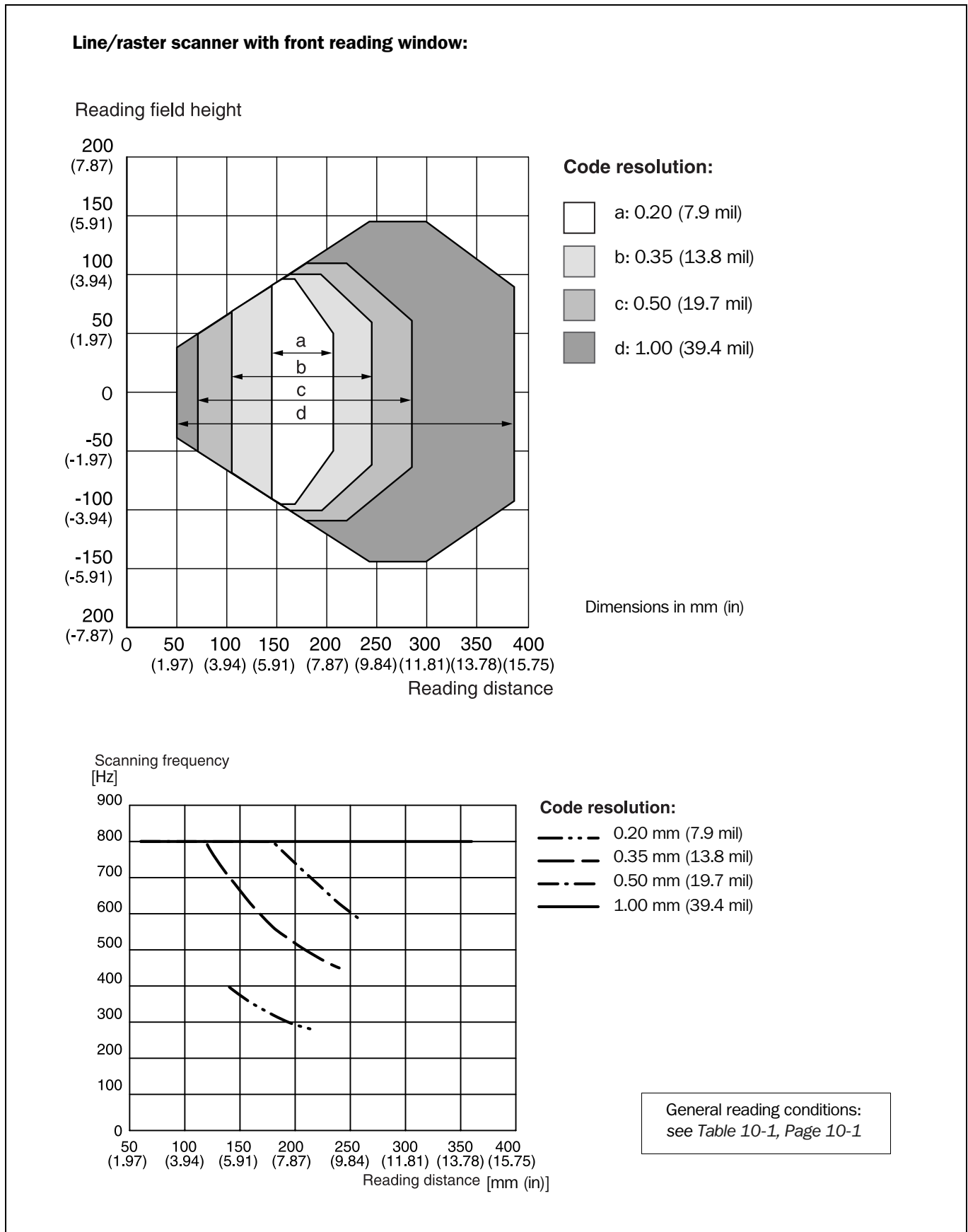

Fig. 10-1: CLV 410-0010/1010: reading range (DOF) and scanning frequency characteristic for line/raster scanner (standard)

10.2.3 Reading field diagram for CLV 412 line/raster scanner (high density)

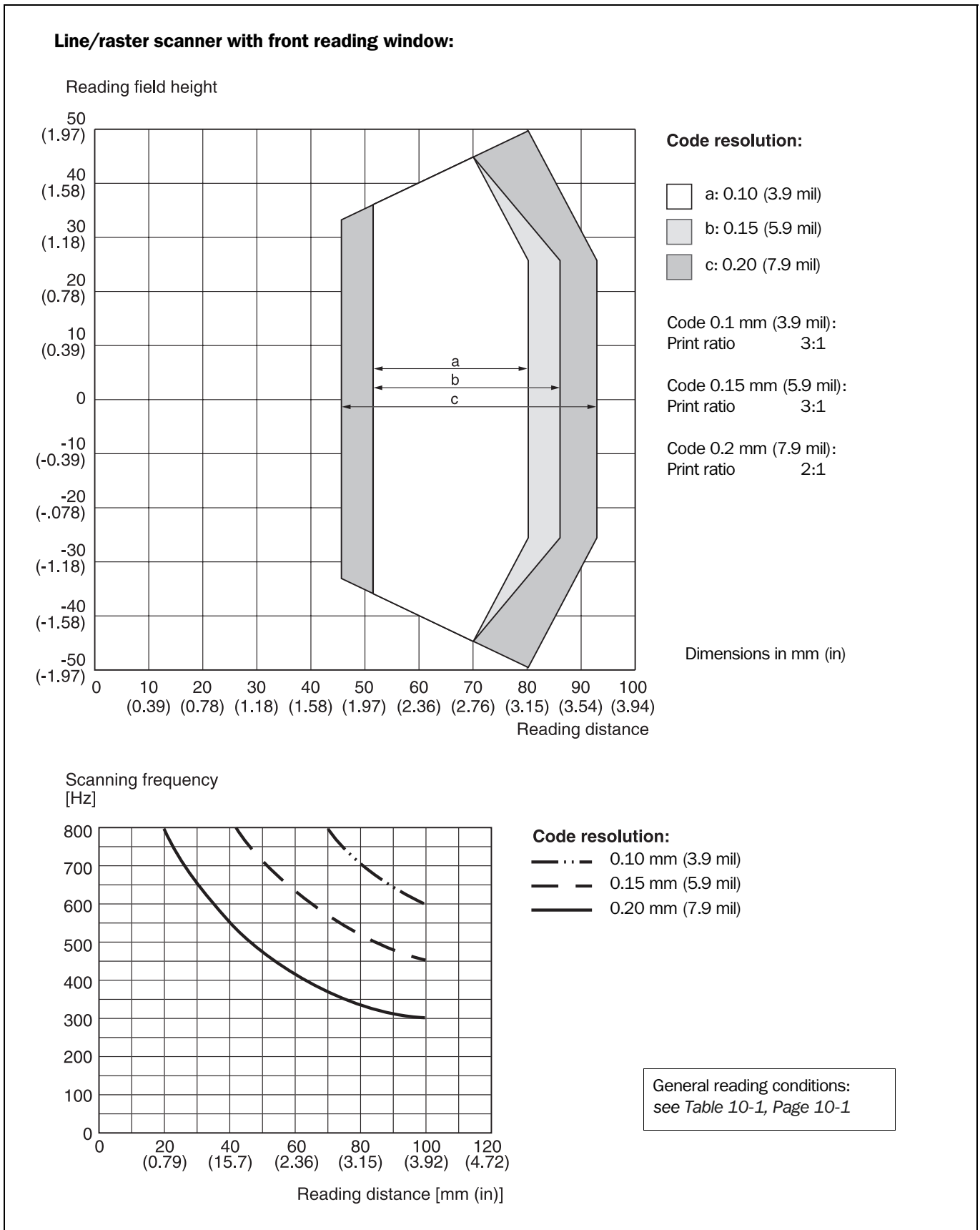

Fig. 10-2: CLV 412-0010/1010: reading range (DOF) and scanning frequency characteristic for line/raster scanner (high density)

10.2.4 Reading field diagram for CLV 410-2010 S02 line scanner (side reading window)

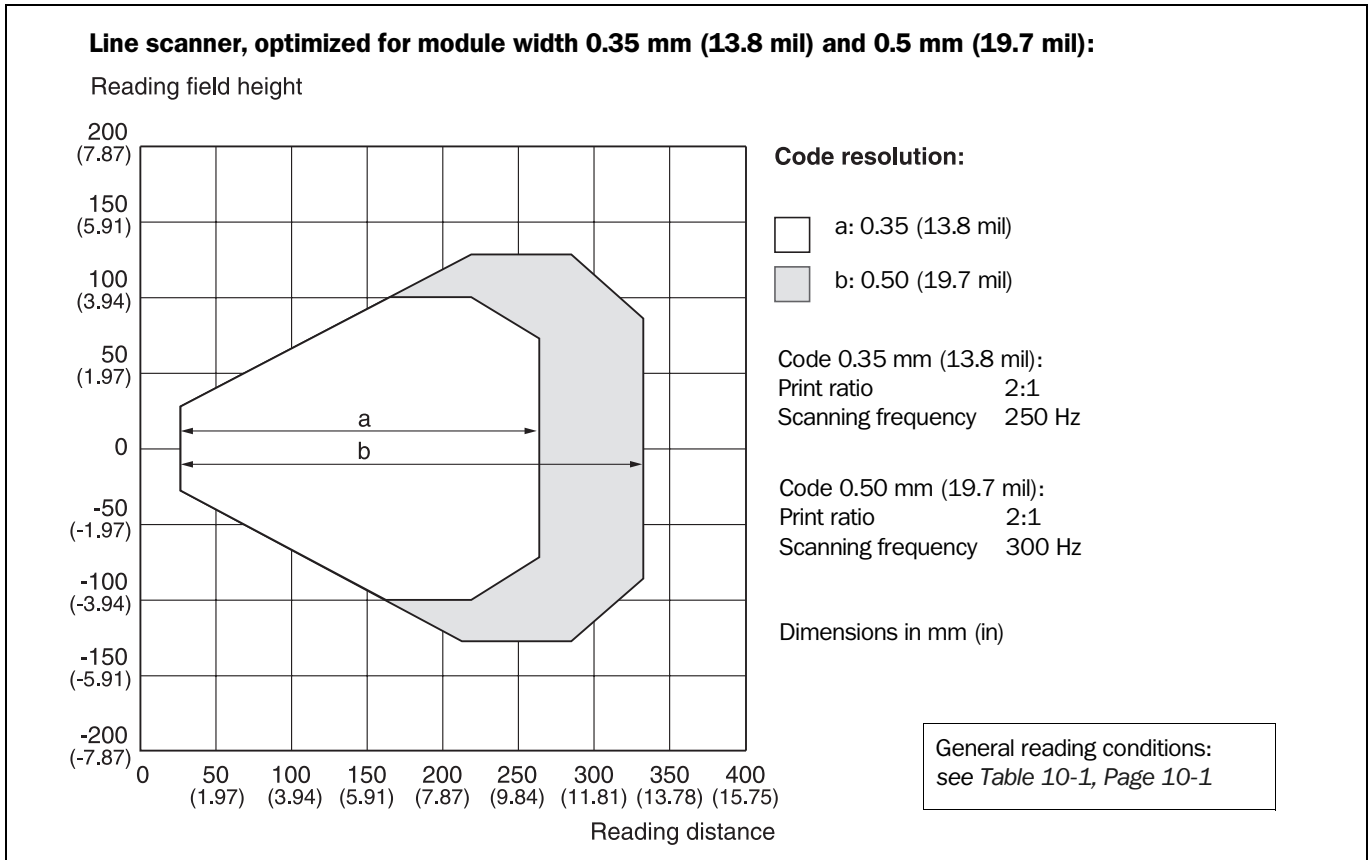

Fig. 10-3: CLV 410-2010 S02: reading range (DOF) for line scanner

10.2.5 Reading field diagram CLV 414 line scanner (short range)

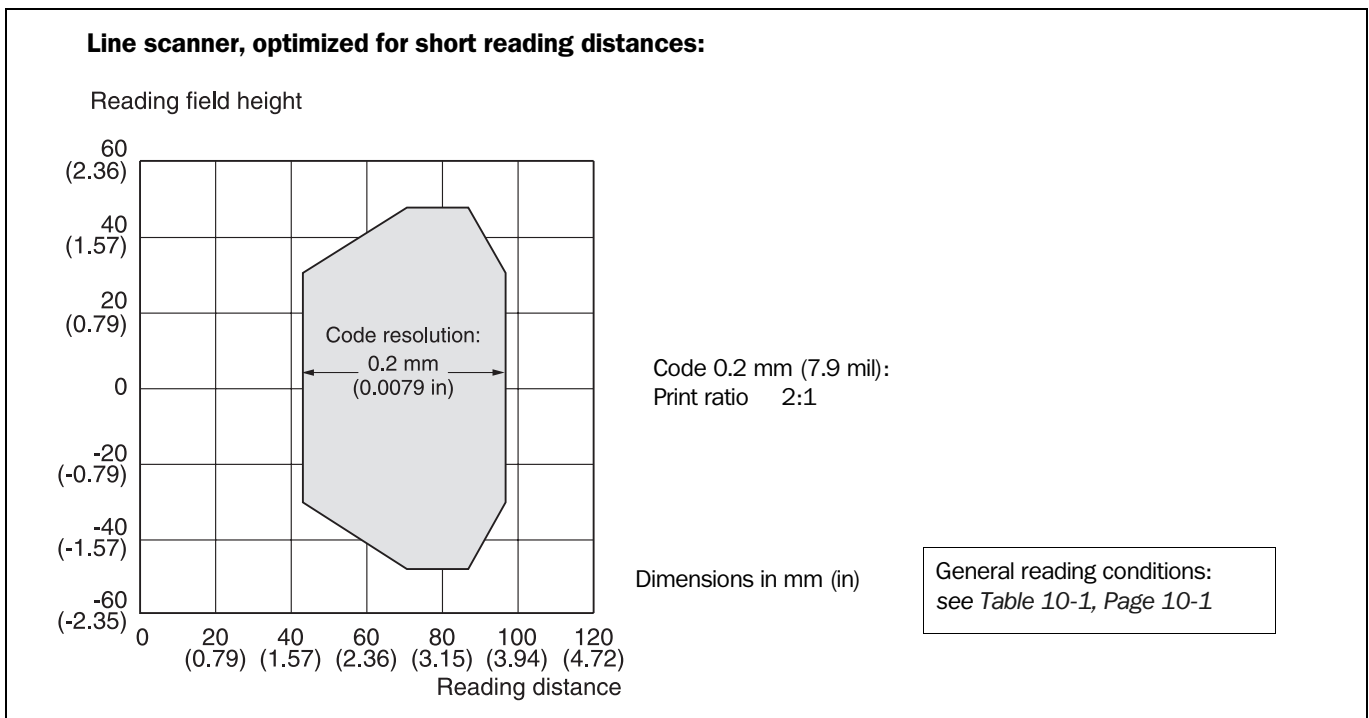

Fig. 10-4: CLV 414-0010: reading range (DOF) for line scanner (short range)



10.3 Installation and operating instructions for the PC-based "CLV Setup" program

The scope of delivery of the CLV includes a CD ROM ("Manuals & Software") containing the "CLV Setup" program.

The following is required to run the program: a PC with at least an 80486 processor running at 66 MHz, 16 MB RAM, CD ROM drive, serial interface, mouse (recommended) and Windows 95™/98™, Windows NT4.0™, Windows 2000™ or Windows XP™.

Approximately 25 MB of hard disk space is required to install CLV Setup (V 4.10) and CLV Assistant, approximately 20 MB to install CLV Setup Help (V 4.10).

For the latest version of the software, see www.sick.com.

10.3.1 Preparations for installation

1. Make sure you have the CD ROM ("Manuals & Software") at hand.
2. Connect the CLV to the CDB 410 or CDM 410 connection module. (See *Chapter 5.5.3 Connecting the power supply, Page 5-5.*)

Temporarily disconnect any existing electrical data connection to the host!

3. Connect the PC to the host interface 2 of the CLV using a 3-core RS 232 data cable (null modem cable) (CDB 410 or CDM 410: connect the PC to the internal, 9-pin "Aux" plug).

See *Chapter 5.5.5 Connecting the PC to the host interface 2 (RS 232), Page 5-7.*

4. Switch on the power supply to the CDB 410 or CDM 410.
Once the CLV has started, it outputs a tone to indicate that the self-test was successfully completed. Shortly afterwards, it outputs two consecutive tones to indicate that it has assumed Reading mode. The "Device Ready" LED lights up.
5. Switch on your PC and start Windows.

10.3.2 Installation

The CLV Setup installation program creates a directory called "CLV", a series of subdirectories and the necessary links. Using the included uninstaller, CLV Setup can be completely removed from the PC. As of version V2.6, CLV Setup will only be available and further developed as a 32-bit application.

Note The following instructions describe how to install the software on Windows 95™. These instructions may differ depending on the operating system you are using (for example, administrator rights are required to install the software on Windows NT4.0).

Initial installation

1. Shut down all the applications running in Windows.
2. Insert the CD ROM into the CD ROM drive.
3. If the auto run function is enabled, the start page (table of contents) of the CD ROM is automatically displayed in the your browser.
4. Select the SOFTWARE folder on top left.
5. Select CLV, ICR, OPS SETUP SOFTWARE in the listing.
A table with CLV Setup information is displayed.
6. Select DOWNLOAD under SOFTWARE FILE.
7. In the FILE DOWNLOAD dialog box select the option to install directly from the CD ROM.
Confirm with OK. The software is automatically saved in the "Programs\CLV" directory on your hard disk.

– or –

Select the option to save the software locally on your local hard disk and confirm with OK.

In the FILE DOWNLOAD dialog box select the desired target directory on your hard disk. The “CLVSetupxx.exe“ file is then saved at this location (xx = version number).

Select OPEN in the dialog box to start the file.

8. The installation program starts and guides you through the installation with screen messages. The program asks you for your user name and company name. This information appears as a header in printouts. “CLV Setup“ and CLV Assistant are installed. The software will be entered in the Windows start menu under “Programs\CLV Setup“.
9. Please read the Readme file, as it contains the latest information and problems regarding CLV Setup.
10. Then confirm the final installation message by clicking “OK“.

CLV Setup Help (Online)

1. Return to the start page of the CD ROM with the opened folder “Software“.
2. Select CLV, CLV HELP SOFTWARE in the listing.
A table with CLV Help information is displayed.
3. Select DOWNLOAD under SOFTWARE FILE.
4. In the FILE DOWNLOAD dialog box select the option to install directly from the CD ROM. Confirm with OK. The software is automatically saved in the “Programs\CLV“ directory on your hard disk.

– or –

Select the option to save the software locally on your local hard disk and confirm with OK.

In the FILE DOWNLOAD dialog box select the same target directory as selected for CLV Setup on your hard disk.

The “CLVHelp.exe“ file is then saved at this location.

5. After downloading the software, select OPEN in the dialog box to start the software. The software is installed in the sub directory “Help“ of the main directory “CLV“. CLV Help will also be entered in the Windows start menu under “Programs\CLV Setup“.
- Restart the PC.
Some Windows DLL files are possibly updated.

The “CLV Setup“ program, the CLV Assistant and the online “CLV Setup Help“ are installed and ready.

The program logs all of the files that are installed to the “install.log“ file. This list is used by the uninstaller to remove CLV Setup and must not be deleted if you want to use the uninstaller at some time in the future.

Updating program

There are two options for installing a new version of CLV Setup:

- You can install the new version and still keep the old version (parallel installation)

– or –

- You can install the new version over the old version (overwrite)

Installing new version and retaining old version

If you want to install the new version and still keep the old version of CLV Setup, follow the procedure described under Initial installation. When the program asks you for the target directory, you must specify a **new directory**. Both versions of the software are then available but may not be started simultaneously.

The configuration files "*.scl" of the old version can be used in the new version and contain the CLV parameter sets. In order to do so, copy the configuration files from the "data" directory of the old version to the "data" directory of the new version.

Installing new version over old version

When installing the new version over the old version, the files of the old version must first be deleted (exception: the "*.scl" configuration files). They contain the parameter sets of the CLV.

The uninstaller of the old version removes the program files. You can use the uninstaller to remove all of the files (with the exception of the configuration files) or only selected files. The default setting is a complete uninstall (the configuration files are not deleted). With the custom uninstall, the files are listed and only selected files are uninstalled. If you choose this uninstall method, ensure that the main directory containing the configuration files "*.scl" is not deleted. We recommend that you move these files to a different directory and copy them back to the "data" directory later.

1. From the Windows Start menu, choose "Programs" and the uninstaller for CLV Setup. The uninstaller starts and guides you step by step through the uninstall procedure.
2. Select the uninstall method (complete or custom).
3. Install the new version of CLV Setup as described under Initial installation. Select the same directory.

The new version of CLV Setup is installed. The configuration files of the old version can be used again.

10.3.3 Starting "CLV Setup"

The "CLV Setup" program is launched with the following default settings:

Communication	COM 1; 9,600 bd; 8 data bits; 1 stop bit; no parity
Transmit control character	Start: STX, Stop: ETX
Receive control character	Start: STX, Stop: ETX
Unit of measure	metric (depending on the selected installation)
Browser	user dependent
Language	as selected for the installation
Company name	as entered for the installation
User name	as entered for the installation
Establish connection to CLV automatically	at startup: yes on scanner selection: yes when the terminal emulator is started/closed: yes
Initial screen	yes
Storage confirmation prompt	yes
Last type selected	CLV 41x
File storage location	"data" (configuration files for CLV)

Table 10-2: Default settings of CLV Setup (extract)

1. Switch on your PC and start Windows.
2. Select CLV SETUP from the Start menu.
The SICK logo is then followed by the initial screen.
3. Confirm the initial screen with "OK".
CLV Setup then checks whether a CLV is connected to the **COM 1** port on the PC and whether the communication parameters on the PC match those on the CLV. If this is the case, the "Connected" status is displayed with the CLV specification in the bottom right corner of the screen, in the status bar. The detected CLV type is displayed in the toolbar in the DEVICE drop-down list (in this case: CLV 41x).

The software then loads the internal device description of the CLV and the defaults settings of the parameters/parameter values from its database and displays these on the tabs. The software then copies the current parameter set from the memory (RAM) of the CLV. This is displayed on the tabs instead of the default settings.

You can edit the current parameter set on the tabs. The default values are displayed when the device is used for the first time.

Troubleshooting

If CLV Setup cannot establish communication, it displays "No connection" in the status bar on the bottom, right-hand side. There are two possible causes for this. Either the CLV is not connected or the communication parameters on the CLV do not match those on the PC. In this case, CLV Setup enters the CLV type of the device it last communicated with in the DEVICE drop-down list on the toolbar. The default setting is CLV 41x the first time CLV Setup is started. The software then loads the internal device description for this type and the default settings of the parameters/parameter values from its database and displays these on the tabs.

1. Connect the PC to the host interface 2 of the CLV using a 3-core RS 232 data cable (null modem cable) (CDB 410 or CDM 410: connect the PC to the internal, 9-pin "Aux" plug).
See Chapter 5.5.5 Connecting the PC to the host interface 2 (RS 232), Page 5-7.
2. Click  (AutoBaud detect) in the toolbar or choose OPTIONS, AUTOBAUD DETECT. CLV Setup scans the serial interface by varying the communication parameters and sends a telegram to the CLV repeatedly. CLV Setup resets temporarily the communication parameters in the CLV 41x to the default setting and indicates the change by outputting a message.

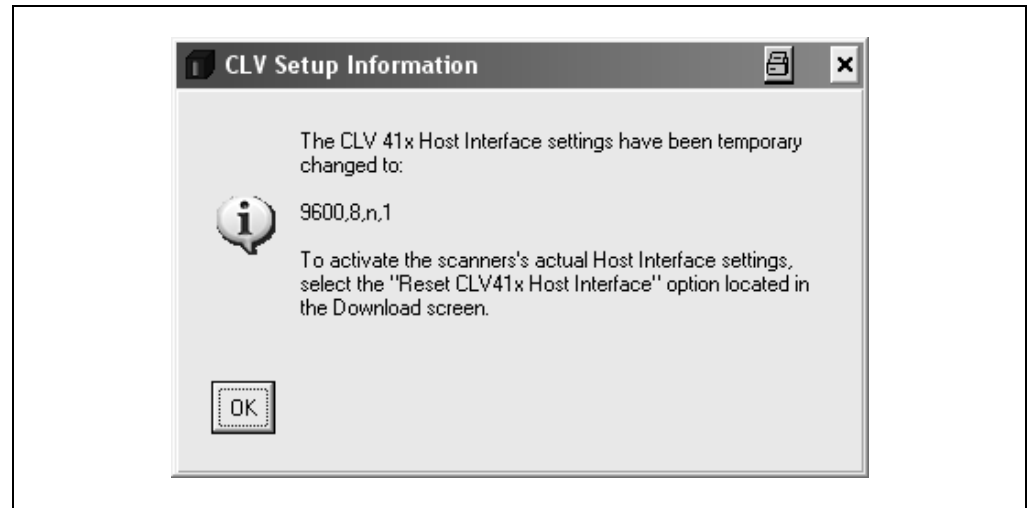

Fig. 10-5: CLV Setup: AutoBaud-Detect: Message about temporarily resetting the communication parameters in the CLV 41x

3. Confirm the AUTO DETECT dialog window with "OK".
As soon as a reply from the CLV is detected, CLV Setup conveys the values found for the communication parameters. Fig. 10-6 shows an example of the AUTOBAUD DETECT result display. CLV Setup displays "Connected" in the status bar on the bottom, right-hand side.

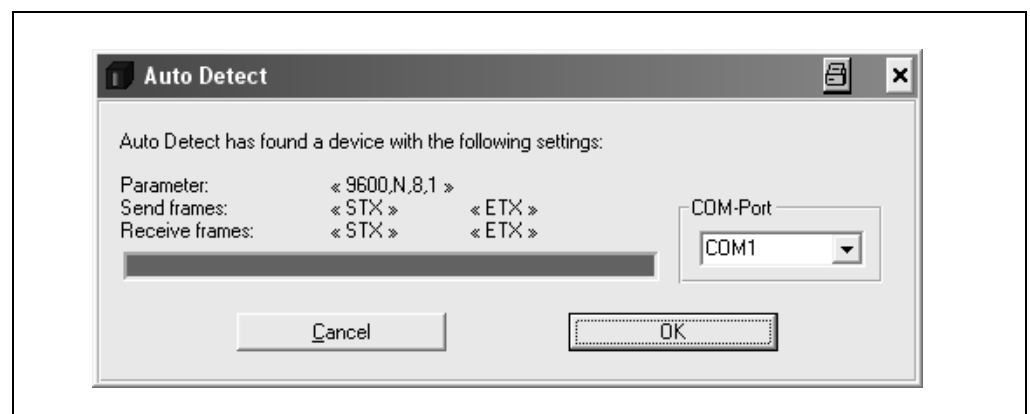



Fig. 10-6: CLV Setup: results of the AutoBaud detect function

4. Confirm the AUTO DETECT dialog window with "OK".
CLV Setup displays the detected CLV type in a separate dialog box and asks you whether you want to upload the current parameter set from the CLV.
5. Confirm the dialog box with "Yes".
CLV Setup then uploads the current parameter set from the RAM of the CLV to its database and displays the values on the tabs.

You can edit the current parameter set on the tabs.

– or –

If the communication parameters are different to the default setting but known proceed as followed:

1. Select OPTIONS, then SERIAL INTERFACE from the menu bar.
CLV Setup displays the current communication parameter settings of the PC in the COM PARAMETERS dialog box.
2. Ensure that the communication parameters of the PC and CLV are identical.
Confirm the dialog box with "OK".
CLV Setup attempts to communicate with the CLV again.
If it is successful, CLV Setup displays "Connected " in the status bar on the bottom, right-hand side.
3. Click  in the toolbar.
CLV Setup then copies the current parameter set from the RAM of the CLV to its database and displays the values on the tabs.

You can edit the current parameter set on the tabs.

Note Restoring the previous communication parameters

If CLV Setup is to reset the communication parameters to the previous values on the next download, click the check box of RESET CLV 41x HOST INTERFACE in the download dialog box (Fig. 10-7).

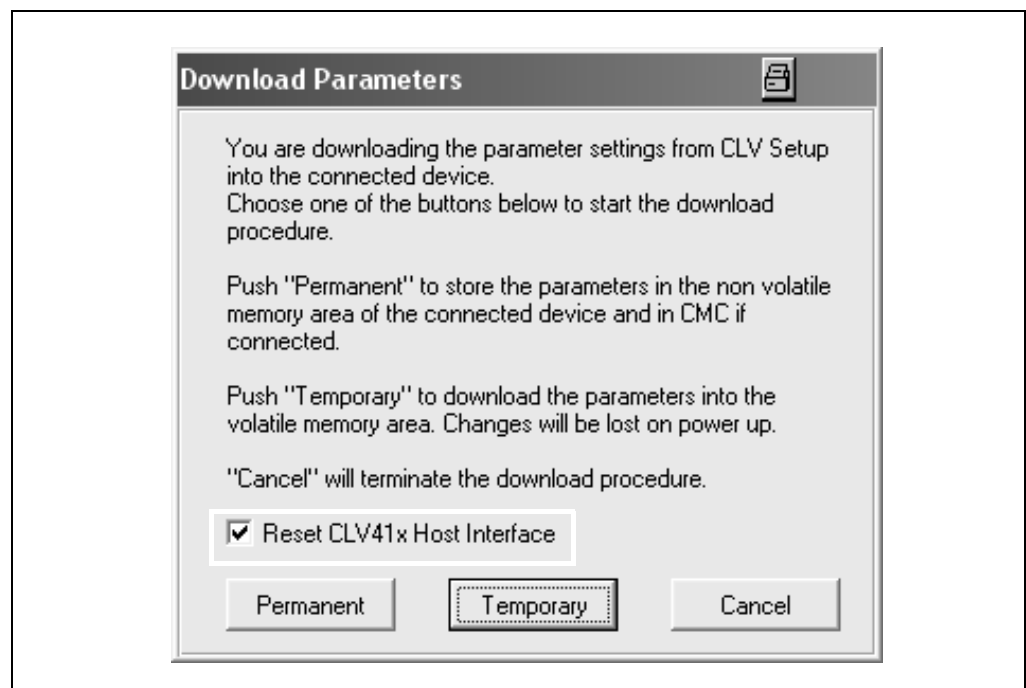

Fig. 10-7: CLV Setup: Restoring the previous communication parameters

Note CLV in network operation (SICK Network RS 485)

During communication between CLV Setup and CLV only the host interface 2 (RS 232) of the CLV is active (by default settings). The CLV need not to be disconnected from the SICK network.

10.3.4 CLV Setup graphical user interface

The graphical user interface (GUI) of CLV Setup is largely self explanatory. The online CLV Setup Help function provides a description of how to use the program under the menu item HELP TO CLV SETUP in the navigation tree. Fig. 10-8 shows the graphical user interface.

The program window of the GUI comprises the following elements:

- Title bar that displays the program name, current configuration file and status (e.g. "No File")
- Menu bar with pull-down menus
- Toolbar with buttons for triggering various functions
- Drop-down list (top right) for selecting the device type
- Frame for displaying the navigation tree of the tabs (on left-hand side)
- Frame for displaying the tabs for CLV 41x (Reading Configuration, Device Configuration, etc.) (on left-hand side). The numbers of displayed tabs depends on the selected items in the navigation tree on the left side. The parameters on the tabs are grouped according to their function. Some of these parameters open further dialog boxes.
- A status bar (at the bottom of the window) with two display fields for the communication activities between CLV Setup and the CLV, display of interface parameters of the PC, error display field (system errors) of the CLV, device specification field and status display for the connection to the CLV.

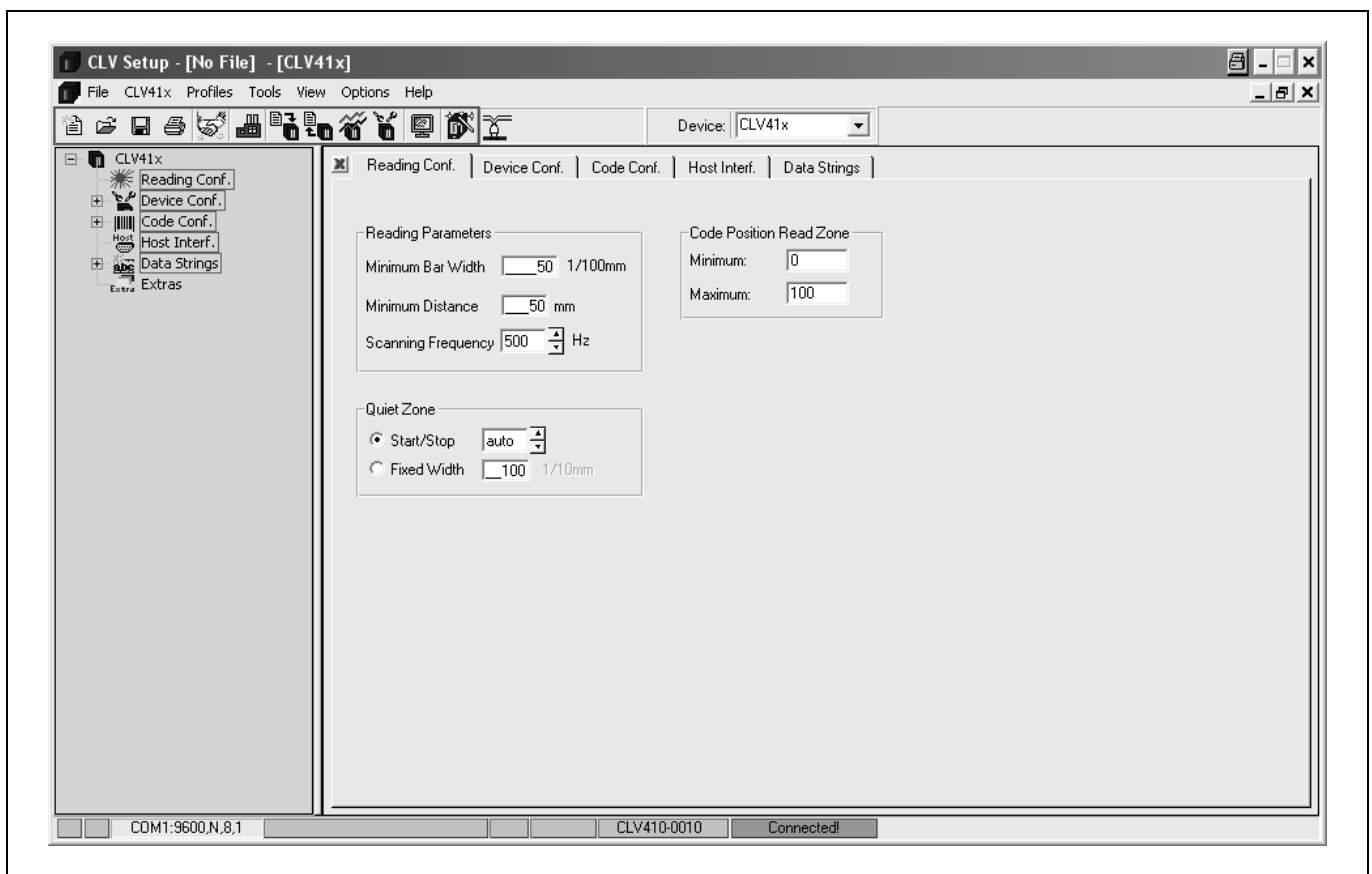

Fig. 10-8: User interface of the "CLV Setup" software

10.3.5 Functions

The "CLV Setup" program (from V 4.0) features functions to carry out the following:

- Loading the default settings of the parameter set from the database of CLV Setup
- Automatic communication attempt with the CLV when the program is started
- Automatic software compatibility check in the CLV
- Uploading and displaying a parameter set stored in the CLV
- Changing the parameters/parameter values on the tabs
- Downloading the changes to the parameter set in the CLV
- CLV Assistant for simplified parameterization
- Saving the changes to the parameter set as a configuration file "*.scl"
- Printing the configuration files
- Exporting the configuration files in RTF format
- Exporting the command strings contained in the profile bar codes in ASCII format
- Printing the parameter set in the form of profile bar codes
- Online access to the CLV via a terminal emulator (select operating mode, start operating functions, log file for communication between the CLV and CLV Setup, extended terminal mode, e.g. for displaying CLV messages)
- AutoBaud detect for automatic communication setup with the CLV
- Selecting the COM port of the PC for adapting the data transfer parameters
- Monitoring the data communication of the CLV host interface
- Selecting the display language
- Selecting the units of measure
- Displaying the last 10 configuration files that were processed
- Saving the CLV type that was selected last
- Automatic storage confirmation prompt when changes are made to the configuration file
- Wizards for individual functions
- Setting switches for starting the program in the "CLVmain.ini" file
- Hot keys [F keys] for essential functions (program operation without a mouse)
- Starting program with SCL file as argument
- Macro player for recording and playing a macro file
- Context-sensitive help via the [F1] key

10.3.6 Hot keys

- [F1] Start "CLV Setup Help" online
- [F2] Open dialog box to execute device functions
- [F3] Upload complete set of parameters from CLV
- [F4] Download complete set of parameters to CLV
- [F5] Open configuration file
- [F6] Save configuration file
- [F7] Load default setting of CLV from CLV Setup database
- [F8] Start AutoBaud Detect
- [F9] Load operating data from CLV to be displayed and reset
- [F10] Open Terminal Emulator

10.3.7 Opening and closing tabs

After starting the user interface, CLV Setup displays those tabs in the frame on right-hand side whose names are framed in the navigation tree on left-hand side. The first tab covers the other tabs in the sequence but their marks are still visible on the top of the tabs. If you click some buttons on a tab in the fore-ground, several sub dialogs will also be opened as tabs and added to the first tab. In the frame, all tabs on the right will then be shifted more to the right side.

To scroll the tabs, use the sliding control elements at the left corner on top of the frame which are displayed by CLV Setup.

You can open and close the tabs in the following way:

In the navigation tree:

- **Opening:**
Double-click the desired entry or put the mouse cursor on the entry and select "Show dialog" in the context menu using the right mouse button.
To display several entries under a branch, click the corresponding "+" symbol.
To hide displayed sub entries, click the corresponding "-" symbol.
- **Closing:**
Put the mouse cursor on the desired entry and select "Hide dialog" in the context menu using the right mouse button.

In the frame for displaying tabs:

- **Opening:**
Click on the desired mark on the top of the tab. If necessary, scroll the tabs.
- **Closing:**
To close the tab in the fore-ground, click on the red cross at the left corner on the top.

Pressing the left mouse button, the left frame with the navigation tree can be move from the program window to a separate position on the screen. If the navigation tree has been closed, it can be reopened using the VIEW menu.



10.3.8 Online help – CLV Setup Help

The online help program "CLV Setup Help" assists you in operating the "CLV Setup" program. The help program runs in an HTML browser (e.g. "Microsoft Internet Explorer™"). You can call up context-sensitive help on each parameter as well as a description of its function.

1. Press the [F1] key.
The browser is launched automatically and displays the help topic.
2. If the program cannot find a browser, CLV Setup asks you to specify the storage location on the hard disk.
Enter the name of the executable file and the path in the dialog box.
3. Use the [Alt]+[Tab] keys to switch between the CLV Setup and CLV Setup Help applications and prevent several browser windows from being opened.
4. To display an overview of the help function, select HELP, CONTENTS from the CLV Setup menu bar.
5. In the left frame click on the desired entry in the navigation tree.
CLV Setup Help then displays the associated help text in the right-hand frame and jumps to the parameter heading.

10.3.9 Transferring parameter sets between CLV Setup and the CLV

See Chapter 6.4.1 Configuring CLV with the user interface of CLV Setup, Page 6-4.

10.3.10 Dealing with unknown parameters





Uploading from the CLV

If the CLV Setup program does not recognize parameters or parameter values of the CLV transferred during the upload, it outputs a warning message. Unknown parameters/parameter values can result from the following, for example: The CLV is a special device or the version of CLV Setup is older than the software of the CLV. CLV Setup displays the unknown parameters in the window on the EXTRAS tab. The parameters are displayed in the form of command strings and can be edited using the command string conventions. In this way, upward compatibility with the CLV is ensured. When the parameter set is saved as a configuration file in CLV Setup, these parameters/parameter values are also taken into account as with a download to the CLV.

Downloading to the CLV

If the CLV does not accept individual parameters or parameter values in the parameter set downloaded with CLV Setup, it outputs a separate warning for each parameter in CLV Setup. This is due to the fact that one of the CLV Setup software versions is newer than the software in the CLV, and it contains new parameters/parameter values arising from the continued development of this CLV type. The affected CLV contains an older software version which does not recognize these parameters/parameter values, however.

We recommend that you check the effects of warnings in the CLV as follows:

1. Check whether the CLV functions correctly after the parameter set is downloaded.
2. Click  in the toolbar.
CLV Setup loads the default settings from the database.
3. Click  in the toolbar.
CLV Setup copies the problem parameter set from the CLV (upload).
4. Click  in the toolbar.
CLV Setup prints out the problem parameter set when you confirm the dialog box.
5. Open the previous configuration file "*.scl" for the CLV.
6. Click  in the toolbar.
CLV Setup prints out the previous parameter set when you confirm the dialog box.
7. Compare the two parameter sets.
To restore the previous status, correct individual parameters in the problem parameter set if necessary and download them to the CLV again.

Opening configuration files "*.scl"

Every time it loads configuration files, CLV Setup checks whether it recognizes all the parameters/values.

If CLV Setup detects an error, it outputs a warning and enters the problem parameter/parameter value in the window of the EXTRAS tab.

10.3.11 Writing a log file in terminal emulator

The terminal emulator can log the communication between CLV Setup and the CLV. CLV Setup stores the data transmitted in both directions with the following identifiers:

CLV -->: CLV sending to CLV Setup

--> CLV: CLV receiving from CLV Setup

1. Click  in the toolbar.
The TERMINAL EMULATOR window is then displayed.
2. On the right, activate the empty checkbox in front of the WRITE LOGFILE radio button.
The SAVE LOG FILE AS... dialog box is then displayed.
3. Enter a file name with the extension ".log" and exit the window with SAVE.
CLV Setup saves the file in the "data" subdirectory and records communication in the log file.
4. To terminate logging, deactivate the checkbox in front of the WRITE LOGFILE radio button or close the terminal emulator.

10.3.12 Starting CLV Setup with an INI file as an argument

When the program is started, CLV Setup can also be transferred the name of an INI file as a parameter. To do so, enter "/INI" in front of the file.

Example:

```
"CLVmain32.exe\data\Set 1_410.scl /INI user.ini"
```

CLV Setup is launched with the initialization data contained in the "user.ini" file and loads the configuration file "Set1_410.scl" from the "data" subdirectory straight away.

The "user.ini" file must be stored in the same directory as "CLVmain32.exe".

You can use this method to link CLV Setup to several different configurations on your Windows desktop.

In this way, for example, you can prevent CLV Setup from attempting to establish a connection when a CLV is not connected.

10.3.13 CLV Assistant

CLV Assistant simplifies parameterization and testing of the CLV, among other things. It carries out configuration of the CLV for a user-specific reading situation with **one** bar code in simple steps. The determined settings are transferred to CLV Setup.

10.4 Configuring the CLV with profile bar codes



10.4.1 Activating AutoSetup with a profile bar code

Profile programming uses special bar codes to parameterize the CLV via the optical interface (reading window) and to initiate device functions. The profile bar codes contain encoded parameter values or commands.

It is not necessary to connect a PC to the CLV in order to carry out profile programming. The working method of AutoSetup explains *Chapter 6.4.4 Configuring the CLV with AutoSetup, Page 6-11*.

Profile bar code no. 10 on the card supplied (no. 8 008 085) starts and ends AutoSetup. It can be presented to the CLV either immediately after the power supply has been switched on, during the wait time in the Free Running mode or during a reading pulse in the Reading mode.

Preparing AutoSetup

1. AutoSetup overwrites important values in the current parameter set of the CLV. If the CLV has already been configured for a particular application, it is advisable to save the existing parameter set as a configuration file "*.scl" in CLV Setup. (See *Chapter 6.4.1 Configuring CLV with the user interface of CLV Setup, Page 6-4*.)
2. Have card no. 8 008 085 with the 12 preprinted profile bar codes ready or print the bar codes as PDF file from the CD ROM („Manuals & Software“). To do so, select the “Programming Profile Bar Codes“ folder in the list on the top left of the start page.

Running AutoSetup after switching on the power supply

1. Fold the card with the profile bar codes in such a way that only profile bar code no. 10 is visible.
2. Switch on the power supply of the CDB 410 or CDM 410 connection module (of the CLV).
The CLV confirms that the self-test has been completed successfully by outputting a tone via the beeper. The "Device Ready" LED lights up. It then switches to the Free Running mode for 5 seconds. The red scan line appears when the "Laser On" LED lights up.
3. Present profile bar code no. 10 within **5 seconds**.
The CLV confirms that AutoSetup has started by outputting a tone via the beeper. It temporarily activates the standard decoder. The "Device Ready" LED is extinguished.
4. Present the application-specific bar code at the **maximum** reading distance for the application. Note the limits of the CLV here (see *reading field diagrams in Chapter 10.2 Specification diagrams, Page 10-1*).
To prevent surface reflections, rotate the bar code towards the CLV approximately 15° away from the vertical axis (*Fig. 4-7, Page 4-5*). Leave the bar code in this position.
5. The CLV confirms that AutoSetup has been completed successfully by outputting two consecutive tones via the beeper and activating briefly the "Result" LED. It overwrites the appropriate parameter values in the current parameter set in the RAM and stores these permanently in the EEPROM. The CLV returns to Reading mode. The "Device Ready" LED lights up.
The CLV only evaluates the presented code type and length the next time a bar code is read.

Running AutoSetup in the Reading mode

1. Fold the card with the profile bar codes in such a way that only profile bar code no. 10 is visible.
2. Start the reading pulse: block the light path of the photoelectric switch or close the switch.
The "Laser On" LED lights up. The red scan line then appears.
3. Present profile bar code no. 10.
The CLV confirms that AutoSetup has started by outputting a tone via the beeper.
The "Device Ready" LED is extinguished.

Continue AutoSetup from Step 4 as in *Running AutoSetup after switching on the power supply, Page 10-16*

AutoSetup in the event of a No Read/Terminating AutoSetup prematurely

If the CLV was not able to execute AutoSetup successfully within approx. 35 s, it cancels the search mode by outputting three consecutive tones via the beeper. Then the CLV starts AutoSetup again with each wrong read.

Terminating AutoSetup:

- Present profile bar code no. 10 again during AutoSetup.
The CLV confirms that AutoSetup has been aborted by outputting a long tone via the beeper.
The current parameter set in the CLV does not change.
The CLV returns to Reading mode.
The "Device Ready" LED lights up.

Running AutoSetup again

1. Switch the power supply of the connection module (of the CLV) off and on again.
2. Present profile bar code no. 10 again after the first tone from the beeper.
The CLV confirms that AutoSetup has started by outputting a tone via the beeper.
The "Device Ready" LED is extinguished.

– or –

1. Start the reading pulse: block the light path of the photoelectric switch or close the switch (default setting: block the polling reflector).
The "Laser On" LED lights up. The red scan line then appears.
2. Present profile bar code no. 10.
The CLV confirms that AutoSetup has started by outputting a tone via the beeper.
The "Device Ready" LED is extinguished.

Continue AutoSetup as described in Step 4 in *Running AutoSetup after switching on the power supply, Page 10-16*.

- If AutoSetup is unsuccessful again, check whether the CLV is able to read the bar code correctly (reading distance, tilt, more than one bar code in the reading field).

Checking the determined read and code configurations

Check the CLV settings with a percentage evaluation. A PC with the "CLV Setup" program installed on it has to be connected for this purpose.

See also *Activating AutoSetup via the user interface of CLV Setup, Page 6-11*.

10.4.2 Profile programming

Profile programming uses special bar codes to parameterize the CLV via the optical interface (reading window). The profile bar codes contain encoded parameter values. It is not necessary to connect a PC to the CLV in order to carry out profile programming.

The profile bar codes are presented to the CLV individually for reading. It copies the parameter values to the current parameter set.

The changes are permanently valid after programming has been completed; in some cases, they also have an immediate effect on the reading and output characteristics of the CLV. The profile bar codes can be presented to the CLV either immediately after the power supply has been switched on, during the wait time in the Free Running mode or during a reading pulse in the Reading mode. During profile programming, the CLV does not output a reading result and does not respond to an external reading pulse.

Profile bar codes are created and printed via the user interface of CLV Setup after the application-specific parameter set has been compiled (Section "Printing profile bar codes"). The enclosed card no. 8 008 085 ("Configuration Profiles for CLV 41x Bar Code Scanners") contains 12 preprinted profile bar codes. They can be used to parameterize tested settings or to trigger specific functions (e.g. AutoSetup). The meaning of the individual profile bar codes is explained in *Table 10-3, Page 10-20*.

Preparing profile programming

1. Profile programming overwrites values in the current parameter set of the CLV. If the CLV has already been configured for a particular application, it is advisable to save the existing parameter set as a configuration file "*.scl" in CLV Setup. See *Chapter 6.4.1 Configuring CLV with the user interface of CLV Setup, Page 6-4*.
2. Have the printed profile bar codes of the compiled parameter set or card no. 8 008 085 ready. Or print the bar codes of the card no. 8 008 085 as PDF file from the CD ROM („Manuals & Software“). To do so, select the "Programming Profile Bar Codes" folder in the list on the top left of the start page.

Performing profile programming after switching on the power supply

1. Switch on the power supply of the CDB 410 or CDM 410 connection module (of the CLV).
The CLV confirms that the self-test has been completed successfully by outputting a tone via the beeper. The "Device Ready" LED lights up. It then switches to the Free Running mode for **5 seconds**. The red scan line appears when the "Laser On" LED lights up.
2. Present the first profile bar code in the printed sequence (or the desired profile bar code from the card) within 5 seconds. Fold the printout/card in such a way that only one profile bar code is visible at any one time.
The CLV confirms that the bar code has been read successfully by outputting a tone via the beeper and waits **10 seconds** for the next profile bar code.
It copies the new parameter value(s) to the current parameter set in the RAM.
3. Present the next profile bar code within 10 seconds.
The CLV confirms that the bar code has been read successfully as described in Step 2.
4. Allow 10 seconds to pass after the last profile bar code has been read.
The CLV exits the programming mode and saves the new parameter values permanently in the EEPROM. It also switches off the laser diode. Following this, it returns to the Reading mode and confirms this by outputting two consecutive tones via the beeper. The "Device Ready" LED lights up.

The CLV then uses the new parameter values.

Performing profile programming in the Reading mode

1. Start the reading pulse: block the light path of the photoelectric switch or close the switch (default setting: block the polling reflector).
The "Laser On" LED lights up. The red scan line then appears.
2. Present the first profile bar code in the printed sequence (or the desired profile bar code from the card).
Fold the printout/card in such a way that only one profile bar code is visible at any one time.
The CLV confirms that the bar code has been read successfully by outputting a tone via the beeper and waits **10 seconds** for the next profile bar code.
It copies the new parameter value(s) to the current parameter set in the RAM.

Continue profile programming from Step 3 in *Performing profile programming after switching on the power supply*, Page 10-18.

Note When the profile bar code is presented to the CLV, note that the changes caused by the new parameter values in the RAM can have an immediate effect on the reading characteristics of the CLV. Under unfavorable conditions, the CLV will only be able to read profile bar codes with great difficulty or not at all.

Changes to the active evaluation range of the scan line (min./max. CP-value) and to increase in the scanning frequency via profile bar code must, therefore, be handled with care.

When changing the reading pulse type, we recommend that you present the corresponding profile bar code (3 LT ...) last so that reading of further profile bar codes in free-running mode is not interrupted.

If the CLV is not able to read any further profile bar codes, it must be corrected accordingly on the tabs via the user interface of CLV Setup. A PC must be connected to the CLV for this purpose.

Canceling profile programming

- Switch off the power supply of the CLV within 10 seconds of presenting the last profile bar code.

The temporary changes to the current parameter set in the RAM are lost.

After the power supply has been switched on again, the CLV uses the values from the last parameter set that was stored permanently.

Printing profile bar codes

Profile bar codes are created and printed out via the user interface of CLV Setup. It is not necessary to connect a PC to the CLV if the current parameter set of the CLV has been saved as a configuration file "*.scl" in CLV Setup.

CLV Setup creates a minimum set of profile bar codes using the parameter values in the tabs and the default settings of the CLV.

This comprises:

- a standard profile (all codes types active or all code types locked)
- a host interface profile
- a greater or smaller number of profile bar codes depending on the difference between the two above-mentioned profiles and the current setting of the entire parameter set.

CLV Setup prints out the bar codes in a defined sequence. The size, position and number of codes on the page can be set.



1. Open the configuration file "*.scl" of the current parameter set.
CLV Setup displays the parameter values of the CLV on the tabs.
2. If desired, make any necessary changes to the parameter set.
Save the new parameter set in the configuration file "*.scl" under a new name.
3. In the menu bar, choose PROFILES and CONFIGURE PRINTING.
Confirm the print option default settings for the profile bar codes or define new ones (see below).
4. In the menu bar, choose PROFILES and PRINT PROFILES.
CLV Setup determines the required number of bar codes.
The PRINT dialog box is then displayed.
5. Specify the number of printouts.
Define the page format if necessary. For this purpose, click the PROPERTIES button.
Relatively long profile bar codes must be printed in landscape format!
6. Confirm the dialog box with "OK".
CLV Setup then prints out the profile bar codes.

Defining print options for profile bar codes

1. In the menu bar, choose PROFILES and CONFIGURE PRINTING.
The BARCODE PRINTING OPTIONS dialog box is then displayed.
2. Choose the desired print options in the BARCODE and PAGE LAYOUT tabs and confirm the dialog box.
CLV Setup then asks if the print options are to be saved.
3. To save the print options, confirm this prompt with "OK".
The SAVE SETTINGS AS... dialog box is then displayed.
4. Enter a file name in the "*.prf" format: Confirm the dialog box with SAVE.
CLV Setup saves the print options in a configuration file in the directory CLV.
The default settings of the print options are active when CLV Setup is started.

Preprinted profile bar codes

The enclosed card no. 8 008 085 ("Configuration Profiles for CLV 41x Bar Code Scanners") contains 12 preprinted profile bar codes. They can be used to parameterize tested settings or to trigger specific functions (e.g. AutoSetup). To print the bar codes as PDF file from the CD ROM („Manuals & Software“), select the "Programming Profile Bar Codes" folder in the list on the top left of the start page.

The individual segments of the card can be folded in such a way that the CLV only reads the desired profile bar code. The profile bar codes are explained in *Table 10-3*, and the functions of the individual parameters in "CLV Setup Help".

Bar code	Function
Profile 1	Default setting of CLV for all parameter values. Code configuration: all code types, except for Pharmacode, enabled for evaluation. Overwrites a code configuration created by AutoSetup!
Profile 2	Only changes configuration of host interface: <ul style="list-style-type: none"> – Data transfer rate: 38,400 bd – Data format: 8 data bits, no parity, 1 stop bit – Handshake: none

Table 10-3: Functions of preprinted profile bar codes on card no. 8 008 085

Bar code	Function
Profile 3	Only changes configuration of host interface: <ul style="list-style-type: none"> – Activation of RS 422/485 interface – SICK network protocol (standard) – Data transfer rate: 38,400 bd – Data format: 7 data bits, parity odd, 1 stop bit – Device number: 99
Profile 4	Only changes configuration of host interface: Reading result is output as soon as evaluation criteria are fulfilled
Profile 5	Only changes configuration of host interface: <ul style="list-style-type: none"> – Output of error status "ST" in the "Separator" block – Output of CLV: <CR> <LF> in the "terminator" block (jumps to start of new line after each code)
Profile 6	Parameterizes CLV as <i>master</i> in master/slave configuration <ul style="list-style-type: none"> – No. of slaves: 1 – Timeout: automatic
Profile 7	As profile 6, but no. of slaves: 2
Profile 8	Parameterizes CLV as <i>slave</i> in master/slave configuration
Profile 9	Parameterizes CLV for pass-through mode: output of " / " and device number in header
Profile 10	Starts and ends CLV AutoSetup
Profile 11	Resets the host interface parameters to the default setting temporarily: <ul style="list-style-type: none"> – Data transfer rate: 9,600 Bd – Data format: 8 data bits, no parity, 1 stop bit
Profile 12	Terminates the temporary default setting of the host interface parameters. Returns the host interface parameters to the previous values

Table 10-3: Functions of preprinted profile bar codes on card no. 8 008 085 (contd.)

10.5 Configuring the CLV with command strings

The CLV can be parameterized and operated via the host interface. Parameters that are not recognized by CLV Setup can also be used by following the conventions for command strings. This enables special devices, for example, to be parameterized and new CLV parameters to be configured which may not be recognized by the CLV Setup program if this is older than the software on the CLV. The CLV Setup user interface is based on the command language.

The command language accesses the CLV command interpreter directly. It must be used carefully. The commands sent to the CLV are executed immediately.

Parameter values that have been changed by commands are initially only active in the current parameter set in the RAM of the CLV. Using a special command, the modified parameter set must also be copied to the EEPROM so that it is stored **permanently**. Otherwise, the changes will be lost when the power supply is switched off.

The Online mode of the terminal emulator in CLV Setup enables the CLV to be parameterized directly with command strings. *Fig. 10-9* contains the initial screen of the terminal emulator with the command field and output window which shows how the PC and CLV communicate with each other.

Note If the CLV does not respond after starting CLV Setup (message "no connection!" in the status bar on the bottom, right-hand side) CLV Setup could not establish communication via the host interface 2 of the CLV.

- To establish the communication carry out the procedure described in *Chapter 10.3.3 Starting "CLV Setup", Page 10-8, Troubleshooting*.



Entering commands in CLVSetup

1. Click  in the toolbar.
The Terminal Emulator window is then displayed. The CLV is in Reading mode.
2. Click PARAMETERIZE under DEVICE MODE.
The CLV cancels Reading mode. The "Device Ready" LED is extinguished. CLV Setup switches the CLV to the Parameter mode by issuing an appropriate command.
In the Parameter mode, all commands begin with the number "3".
3. Enter the desired command in the command field ① and press the [Return] key.
The command is then sent to the CLV.
With a few exceptions, the CLV replies to a command with correct syntax with an echo.
Example:
Entering "3?LT" causes the CLV to output the parameter values of the reading pulse in encoded form in the output window ②.

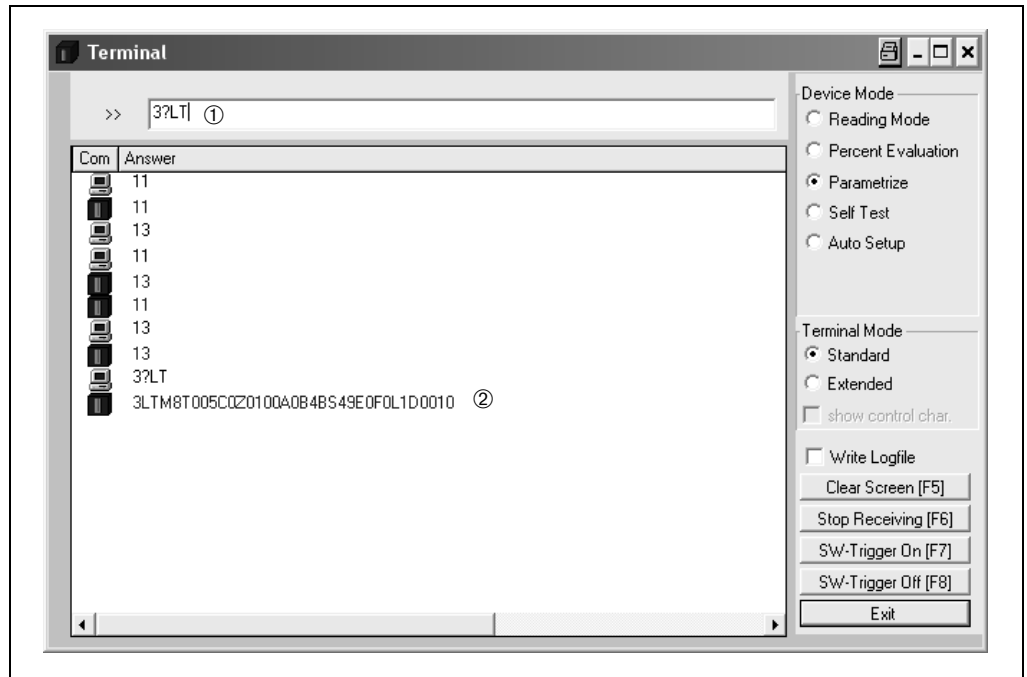

Fig. 10-9: CLV Setup: entering commands in the terminal emulator

- To return to Reading mode click the READING MODE radio button.
The "Device Ready" LED lights up.

Note Changes that are made directly to parameter values in the CLV using command strings are only registered and displayed in CLV Setup after the current parameter set has been uploaded from the CLV.



A list of command strings is available on request.

Outputting command strings for all the parameter settings

You can output a list of all the parameter settings configured with CLV Setup in ASCII format. To do so, proceed as follows:

- In the menu bar, choose EXPORT PARAMETERS under CLV 41x.
Starting from the default settings, CLV Setup collects all the command strings required to parameterize the default configuration and customized settings.
The SELECT FILE NAME FOR PARAMETER EXPORT dialog box is displayed.
- Enter a file name and click the SAVE button.
CLV Setup saves the data as a text file in the directory shown.

You can open this text file using any Windows text editor.

If the commands are sent from the host/PLC to the CLV for configuration, note that "3 EEW" has to be sent as the last command to ensure that they are permanently transferred to the CLV (EEPROM).

10.6 Calculating parameter values for setting the CLV

10.6.1 Calculating the number of scans

The maximum number of scans possible for a bar code depends on the conveyor velocity v .

Line scanner: ladder-type bar code arrangement

Line scanner: side reading at object

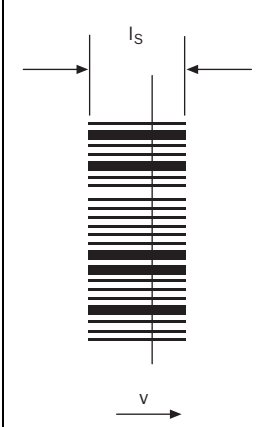

Specifications:

Number of scans $n = ?$
 Conveyor velocity $v = 1.5 \text{ m/s}$
 Bar length $l_s = 20 \text{ mm (0.8 in)}$
 Scanning frequency $f = 600 \text{ Hz}$
 Barcode 100 % readable

$$v = \frac{s}{t}$$

$$v = \frac{l_s}{n \times t_{\text{scan}}}; \quad t_{\text{scan}} = \frac{1}{f}$$

$$v = \frac{l_s}{n} \times f$$

$$n = \frac{l_s}{v} \times f$$

$$n = \frac{0,02 \text{ m}}{1,5 \text{ m/s}} \times 600/\text{s} \quad \mathbf{n = 8}$$

Fig. 10-10: Line scanner: calculating the number of scans for ladder-type bar code arrangements

Line scanner: fence-type bar code arrangement

Line scanner: side reading at object

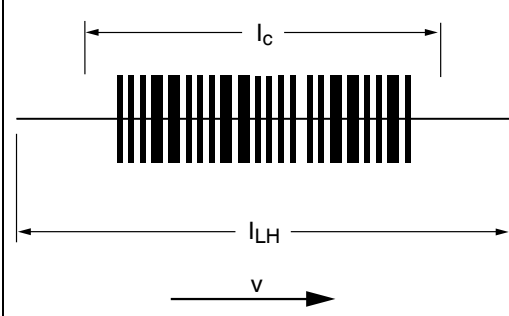

Specifications:

Number of scans $n = ?$
 Conveyor velocity $v = 2 \text{ m/s}$
 Code length with rest zone $l_c = 150 \text{ mm (5.9 in)}$
 Reading field height $l_{LH} = 400 \text{ mm (15.8 in)}$
 Scanning frequency $f = 600 \text{ Hz}$
 Bar code 100 % readable, all scans on the code window $s = l_{LH} - l_c$

$$v = \frac{s}{t}$$

$$v = \frac{(l_{LH} - l_c)}{n \times t_{\text{scan}}}; \quad t_{\text{scan}} = \frac{1}{f}$$

$$v = \frac{(l_{LH} - l_c)}{n} \times f$$

$$n = \frac{(l_{LH} - l_c)}{v} \times f$$

$$n = \frac{(0,4 - 0,15) \text{ m}}{2 \text{ m/s}} \times 600/\text{s} \quad \mathbf{n = 75}$$

Fig. 10-11: Line scanner: calculating the number of scans for fence-type bar code arrangements

10.7 Tables

10.7.1 Calculating code length of a bar code

The code length of a bar code is the number of used characters in the printed code including the check digit (if present). This code length must be specified in CLV Setup.

If the code type of a bar code is known, the code length can be calculated by counting the bars and gaps. The relevant formulas are provided in *Table 10-4*.

1. Count the bars and gaps as specified in *Table 10-4*. Do not forget to include the start and stop characters.
2. Calculate the code length using the formula in the table.
3. Enter the value in CLV Setup as described in column 4 of the table.

Code type	Count	Calculation of code length ^{1) 2)}	Entry in CLV Setup
Code 39	Number of bars	$l_{\text{Code}} = \frac{\text{Number} - 10}{5}$	Calculated code length
2/5 Interleaved	Number of wide elements (bars and gaps)	$l_{\text{Code}} = \frac{\text{Number} - 1}{2}$	Calculated code length
EAN	not applicable	13 characters (normal version) 8 characters (short version)	Activate 13-digit Activate 8-digit
UPC	not applicable	12 characters (UPC A, normal version) 6 characters (UPC E, short version)	Activate version A Activate version E
Codabar	Number of bars	$l_{\text{Code}} = \frac{\text{Number} - 8}{4}$	Calculated code length
Code 128 (character set A)	Number of bars	$l_{\text{Code}} = \frac{\text{Number} - 10}{3}$	Calculated code length
Code 93	Number of bars plus separator after the stop character	$l_{\text{Code}} = \frac{\text{Number} - 13}{3}$	Calculated code length
EAN 128	Number of bars	$l_{\text{Code}} = \frac{\text{Number} - 10}{3}$	Calculated code length
Pharmacode	Number of bars	Number	Number = code length
<p>1) Check digit optional with Code 39, 2/5 Interleaved, Codabar. Check digit always integrated in printed bar code with EAN, UPC, Code 128, Code 93, EAN 128 (suppressed automatically when the CLV reading result is output)</p> <p>2) With only a few exceptions, every printed character to be decoded corresponds to an ASCII character. With Code 39 extended, Code 93, Code 128 and EAN 128, the number of characters in the data string of the CLV can be larger than the number of characters in the printed code because it comprises several character sets.</p>			

Table 10-4: Formulas for calculating the code length of a bar code

10.8 Special applications and procedures

10.8.1 Triggering the teach-in match code 1 via the "Sensor 2" switching input

In Reading mode, the CLV compares up to two match codes with the bar codes it recorded in the reading pulse. The result status of the code comparison is signaled by the corresponding functional assignment via the "Result 1" to "Result 3" switching outputs and the beeper. The "Result" LED only lights up (until the end of the next reading pulse) to indicate a successful code comparison.

The match codes can also be used as output filters for the host interface. In this case, when a good read occurs, the CLV only outputs those bar codes that have the same code type, code length, and data content as the match code(s).

A match code can contain max. 50 characters in the range 32 to 137 dec. and must be a code type that can be evaluated by the CLV.

Using the "Sensor 2" switching input, the CLV can:

- teach in match code 1 via its optical interface (reading window) and store it permanently in the parameter set instead of entering it with the CLV Setup program. The code type, code length, and data content are entered in the parameter set.
- activate the code comparison. The status remains active until the power supply to the CLV is switched off.

Before the match code can be read, a switch must be connected (Fig. 10-12), the functional assignment of the switching input changed and Teach-in mode selected.

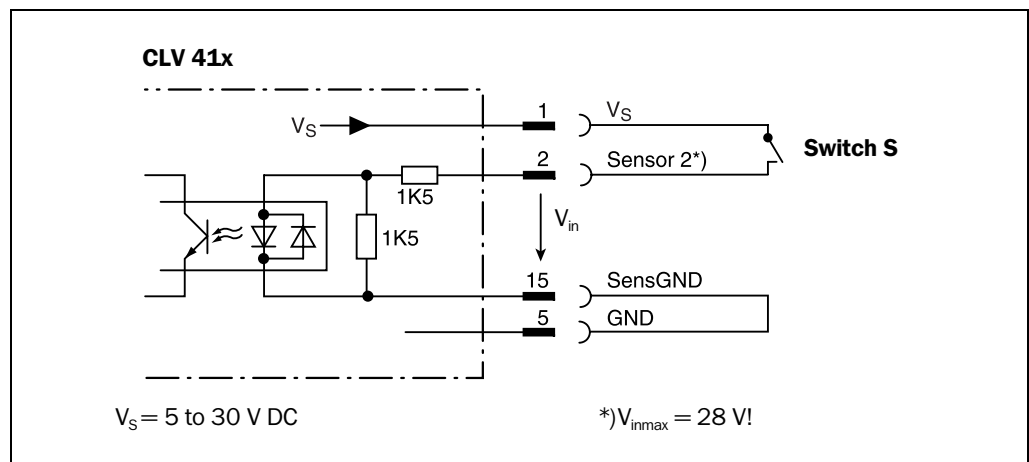

Fig. 10-12: "Sensor 2" configuration for triggering the teach-in match code 1

There are two modes for teaching in match code 1:

- Dynamic teach-in of match code 1
The code type that corresponds to the match code must be activated for the evaluation in the CLV. The CLV must be pulsed manually so that it can read the match code. After the teach-in procedure has been successfully completed, the CLV still continues to output bar codes of all the code types that were previously enabled.
- Static teach-in of match code 1 with/without Pharmacode
The CLV can also read a match code whose code type is implemented, but not yet enabled for evaluation. A reading pulse starts automatically at the start of the teach-in procedure. The CLV terminates the reading pulse once the teach-in procedure has been successfully completed. In Reading mode, it only outputs bar codes which match the code type and length of match code 1. All other code types are locked. To ensure that the match code is read reliably, the CLV temporarily sets the number of multiple

reads to 30. The previous code configuration is kept if a match code is not detected during the teach-in procedure.

Since the CLV can essentially interpret every code as a Pharmacode, the "static with Pharmacode" variant should only be activated if this code is actually to be programmed (taught-in) as a match code. The Pharmacode in this case must comprise a **minimum of 4 characters**.

Check whether the programmed Pharmacode is correct by uploading it from the CLV using the CLV Setup program!

Resetting the counters:

With static teach-in, the CLV can optionally reset the daily operating data for each newly taught-in match code 1. This includes the following counters:

- daily operating hours
- no. of reading intervals
- no. of good reads

Additionally there are two counters which will be not lost if the CLV is switched off:

- no. of good reads
- no. of no reads

Both 8-digit counters can only be queried by the command string <Start>4?CC<Stop>. They are not represented in CLV Setup.

Once match code 1 has been programmed, the code comparison can also be activated with the CLV Setup program (either temporarily or permanently, depending on the download option). Activating the function with the program has a higher priority than with the "Sensor 2" switching input. In this case, the switch must be open when the power supply to the CLV is switched on.

Match code 2 can only be defined and activated using the CLV Setup program or command strings, irrespective of the teach-in procedure.

Note If match code 1 is set using the teach-in method, it must not be modified with CLV Setup (or command strings) until the CLV is switched off again. The method used to set the match code cannot be mixed. This does not affect match code 2.



Preparing for teach-in:

1. Switch off the power supply to the CDB 410 or CDM 410 connection module.
2. Connect the switch in the CDB 410 or CDM 410 connection module at the "Sensor 2" switching input of the CLV as shown in *Fig. 10-12*. Connect the "SensGND" and "GND" signals.
3. **Open the switch!** ("Sensor 2" switching input must be at zero current).
4. Connect the PC to the host interface 2 (RS 232) of the CLV. For this purpose, connect a 3-core RS 232 data cable (null modem cable) to the internal 9-pin "Aux" plug of the module.

See *Chapter 5.5.5 Connecting the PC to the host interface 2 (RS 232)*, Page 5-7.

Temporarily disconnect any existing electrical data connection to the host!

5. Switch on the power supply to the CDB 410 or CDM 410 connection module. Once the CLV has started, it outputs a tone to indicate that the self-test was successfully completed. Shortly afterwards, it outputs two tones to indicate that it has assumed Reading mode. The "Device Ready" LED lights up.

6. Start Windows and "CLV Setup" on your PC.
See *Chapter 10.3.3 Starting "CLV Setup"*, Page 10-8.
7. Upload the current parameter set from the CLV.
CLV Setup displays the current values on the tabs.
8. If you have not already done so, save the parameter set as a configuration file "*.scl" in CLV Setup.

a) Dynamic teach-in procedure



Configuring the dynamic teach-in procedure:

- Accompanying measure: change the reading pulse for teach-in
1. Select the DEVICE CONFIGURATION tab.
 2. Click the DYNAMIC option in the TEACH-IN group.
 3. If necessary proceed as follows to activate the output filter in the CODE COMPARISON group:
 - Click the CODE #1 ACTIVE checkbox.
 - Click the FILTER FOR OUTPUT checkbox.
 - Click the CODE #1 ACTIVE checkbox again.
The code comparison is now no longer permanently activated via the user interface. The output filter, however, remains active.
 4. Click the READING TRIGGER PARAMETERS button.
 5. Click the SERIAL INTERFACE radio button in the READING TRIGGER SOURCE group.
 6. Confirm the dialog box with "OK".
 7. Click the RESULT OUTPUT PARMETERS button.
 8. In the dialog box under RESULT FUNCTIONS, choose the MATCH 1 option for e.g. Result 2 in the drop-down list.
 9. Select the CODE CONFIGURATION tab.
 10. Activate the code type of the match code in the SYMBOLOGIES group.
 11. Click the EDIT button.
 12. Choose the code type tab and click the FREE radio button in the CODE LENGTH group.
 13. Close the dialog box.
 14. Perform a download to the CLV. This is done by clicking  in the toolbar.
The DOWNLOAD PARAMETER dialog box is displayed.
 15. Confirm the dialog box by selecting the PERMANENT save option.

Carrying out the dynamic teach-in procedure:

1. Click  in the toolbar.
The terminal emulator is launched. The CLV is in Reading mode.
2. **Close the switch** to connect the power supply to the "Sensor 2" switching input.
3. Click PARAMETERIZE under DEVICE MODE.
The CLV switches to PARAMETER MODE.
4. Click READING MODE under DEVICE MODE.
The CLV returns to Reading mode and polls the condition of the "Sensor 2" switching input. It also activates code comparison at this time.

– or –

As an alternative to steps 3 and 4, switch the power supply to the connection module (CLV) off and on again. The CLV outputs two consecutive tones to indicate that it has switched to Reading mode.

5. **Open the switch** to interrupt the power supply to the "Sensor 2" switching input. The CLV activates teach-in mode for match code 1.
6. Click the SW-TRIGGER ON button or press [F7] key. The CLV starts the reading interval and waits for the match code.
7. Present the match code.
8. Click the SW-TRIGGER OFF button or press [F8] key. The CLV confirms that the read was successful by emitting a tone and then ends the reading interval. Match code 1 is now stored in the RAM.
9. **Close the switch** to reconnect the power supply to the "Sensor 2" switching input. The CLV saves match code 1 (code type, code length, and data content) permanently in the parameter set stored in the EEPROM. It compares every bar code it reads with match code 1 until the power supply is switched off. In doing so, it outputs the result of the comparison via the "Result 2" output with the predefined pulse length. The "Result" LED only lights up (until the end of the next reading pulse) to indicate a successful code comparison.
10. **Keep the switch closed.** The CLV will activate teach-in mode again if you open the switch!

Replacing the match code:

To replace the current match code 1 with a new match code using the teach-in method, simply repeat steps 5 to 9.

Checking the programmed match code in the CLV:

1. Switch the power supply of the connection module (of the CLV) off and on again.
2. Perform an upload from the CLV. This is done by clicking  in the toolbar.
3. The code type and data content of match code 1 are shown in the CODE COMPARISON group on the DEVICE CONFIGURATION tab.

Resetting the reading pulse:

1. Select the DEVICE CONFIGURATION tab.
2. Click the READING TRIGGER PARAMETERS button.
3. Click the current option in the READING TRIGGER SOURCE group in the dialog box.
4. Perform a download to the CLV. This is done by clicking  in the toolbar.
5. Confirm the dialog box by selecting the PERMANENT save option. The CLV then uses the reading pulse type that was set before the teach-in procedure.

b) Static teach-in procedure

Configuring the static teach-in procedure:

1. Select the DEVICE CONFIGURATION tab.
2. Click the STATIC WITHOUT PHARMACODE, or STATIC WITH PHARMACODE to read a Pharmacode, in the TEACH-IN group.
3. If necessary, click the WITH COUNTER RESET option in the COUNTER RESET group.
4. If necessary proceed as follows to activate the output filter in the CODE COMPARISON group:



- Click the CODE #1 ACTIVE checkbox.
 - Click the FILTER FOR OUTPUT checkbox.
 - Click the CODE #1 ACTIVE checkbox again.
The code comparison is now no longer permanently activated via the user interface.
The output filter, however, remains active.
5. Click the RESULT OUTPUT PARAMETERS button.
 6. In the dialog box under RESULT FUNCTIONS, choose MATCH 1 in the drop-down list for e.g. Result 2.
 7. Perform a download to the CLV. This is done by clicking  in the toolbar.
 8. Confirm the dialog box by selecting the PERMANENT save option.

Note Before you can use the static teach-in method, the parameter sets in the RAM and EEPROM of the CLV must be identical. This is done with the PERMANENT saving option. If you select the TEMPORARY option instead, the CLV loads the default settings after the teach-in function has been carried out and the power supply switched off.

Carrying out the static teach-in procedure:

1. Click  in the toolbar.
The terminal emulator is launched. The CLV is in Reading mode.
2. **Close the switch** to connect the power supply to the "Sensor 2" switching input.
3. Click PARAMETERIZE under DEVICE MODE.
The CLV switches to Parameter mode.
4. Click READING MODE under DEVICE MODE.
The CLV returns to Reading mode and polls the condition of the "Sensor 2" switching input. It also activates code comparison at this time.

– or –

As an alternative to steps 3 and 4, switch the power supply to the connection module (of the CLV) off and on again. The CLV outputs two consecutive tones to indicate that it has switched to Reading mode.

5. **Open the switch** to interrupt the power supply to the "Sensor 2" switching input.
The CLV activates teach-in mode for match code 1.
It starts the reading interval automatically and waits for the match code.
6. Present the match code.
The CLV confirms that the read was successful by outputting a tone and then ends the reading interval. Match code 1 is now stored in the RAM.
7. **Close the switch** to reconnect the power supply to the "Sensor 2" switching input.
The CLV saves match code 1 (code type, code length and data content) permanently in the parameter set stored in the EEPROM.
It compares every bar code it reads with match code 1 until the power supply is switched off. In doing so, it outputs the result of the comparison via the "Result 2" output with the predefined pulse length. The "Result" LED only lights up (until the end of the next reading pulse) to indicate a successful code comparison.
If the CLV was not able to read the match code, the reading interval is terminated when the switch is closed. The previously set code configuration remains intact.
8. **Keep the switch closed.**
The CLV will activate teach-in mode again if you open the switch!

Replacing the match code:

To replace the current match code 1 with a new match code using the teach-in method, simply repeat steps 5 to 7.

Checking the programmed match code in the CLV:

Proceed as described in steps 1 to 3 in "**a) Dynamic teach-in procedure**", Page 10-28.

Activating/deactivating the code comparison via the "Sensor 2" switching input**Activating the code comparison function:**

1. Close the switch before switching on the power supply to the CLV.
2. Switch on the power supply.
The CLV activates the code comparison function.
3. Do not open the switch while the CLV is in operation.

Deactivating the code comparison function:

1. Switch off the power supply to the CLV.
2. Open the switch.
3. Switch on the power supply.
The CLV starts Reading mode without the code comparison.

Assigning output functions to the "Result 1" to "Result 3" switching outputs and beeper:

CLV can output the result of the code comparison in the following functions:

- No match (code does not match either match code)
- Match 1 (matches match code 1)
- Mismatch 1 (does not match match code 1)
- Match 2 (matches match code 2)^{*)}
- Mismatch 2 (does not match match code 2)^{*)}
- Match 1 or 2 (matches match code 1 or 2)
- Match 1 and 2 (matches match code 1 and 2)^{*)}

^{*)} only relevant if match code 2 is active



When configuring the teach-in function for match code 1, define the following settings:

1. Select the DEVICE CONFIGURATION tab.
2. Click the RESULT OUTPUT PARAMETERS button.
3. Choose the required option for Result 1 to Result 3 and beeper from the RESULT FUNCTIONS drop-down list.
4. Perform a download to the CLV. This is done by clicking  in the toolbar. Confirm the dialog box by choosing the PERMANENT storage option.



10.8.2 Structure of a daisy chain configuration (data forwarding or master/slave arrangement)

See *Technical Information "Master/Slave with Bar Code Scanners from the CLV Series"*
(order no. 8 007 675, English edition)



10.8.3 Structure of a SICK network (RS 485)

See *"CLX 200 Network Controller" Technical Description*
(order no. 8 007 157, German/English edition)



10.8.4 Connection to Profibus DP

See *operating instructions "BMV/BMH 10 for Profibus DP"*
(order no. 8 008 825, English version)



10.8.5 Connection to DeviceNet

See *operating instructions "BMV/BMH 10 for DeviceNet"*
(order no. 8 008 972, English version)



10.8.6 Connection to Interbus S

See *technical information "BMS 10/20 for Interbus S"*
(order no. 8 007 546, English version)



10.8.7 Connection to Ethernet

See *operating instructions "BMV/BMH 10 for Ethernet"*
(order no. 8 009 398, English version)

10.9 Replacing a CLV (copying the parameter set)

There are two methods of replacing a CLV and transferring the current parameter set to the new device:

- by using the profile bar codes
- by downloading the parameters from CLV Setup

The parameter set can only be transferred between identical device types (e.g. from one CLV 410 to another CLV 410, etc.).

10.9.1 Transferring the parameter set using the profile bar codes

To transfer the parameter set using the profile bar codes, you do not need to connect the device to a PC. The parameter set of the CLV that is to be replaced must be available in the form of archived profile bar codes or at least as a configuration file in CLV Setup. Otherwise, the replacement device must be configured from scratch.

The procedure for printing out the profile bar codes is described in *Chapter 10.4.2 Profile programming, Page 10-18*.

1. Switch off the power supply of the CDB 410 or CDM 410 connection module (of the CLV).
2. Disconnect the CLV connector from the CDB 410 or CDM 410 connection module.
3. Remove the CLV from the bracket.
Before doing so, mark the position and alignment on the bracket/station.
4. Install, align, and connect the replacement device.
5. Switch on the power supply to the CDB 410 or CDM 410.
The "Device Ready" LED of the CLV lights up. The CLV outputs a tone by the beeper to indicate that it is ready to read the profile bar codes.
6. Present the first profile bar code **within 5 seconds**.
The CLV confirms that the bar code has been read successfully by outputting a tone via the beeper and waits **10 seconds** for the next profile bar code.
7. Present all of the other profile bar codes consecutively in the **printed sequence**.
8. Then allow the final wait time (10 seconds) to elapse.
The CLV outputs two consecutive tones to indicate that it has switched to Reading mode.

The new CLV is now ready to use the transferred parameter set.

Troubleshooting



If the software version on the replacement (new) device is older than the version on the old device (e.g. new device is from warehouse stock), the profile bar codes may contain coded parameters or parameter values that cannot be interpreted by the older software of the replacement device. The CLV, however, reads all of the profile bar codes. But this does not indicate that the CLV can use all the parameters or parameter values.

- Use the CLV Setup program to check whether the new CLV is functioning correctly. To do so, connect the PC to the host interface 2 (RS 232) on the CLV.

Temporarily disconnect any existing electrical data connection to the host!

Check whether all of the parameter settings used are necessary to configure the CLV for the current reading application. If necessary, replace the software version in the new device.

If the software version on the new device is more recent than that on the old one, the default settings in the imported parameter set will include parameters that were not contained in the old version.

- Upload the parameter set with the CLV Setup program and check whether the new parameters are relevant for configuring the CLV for the current reading application. If necessary, change the parameter values and download the parameter set to the CLV again. Save the new parameter set as a configuration file in CLV Setup and print it out as profile bar codes for archiving purposes.

See also Chapter 10.3.10 *Dealing with unknown parameters*, Page 10-14.

10.9.2 Downloading the parameter set



To download the parameter set, you must connect a PC running the CLV Setup software to the replacement device. The parameter set of the CLV that is to be replaced must be available as a configuration file in CLV Setup, otherwise the device must be configured from scratch.

1. Switch off the power supply of the CDB 410 or CDM 410 connection module (of the CLV).
2. Disconnect the CLV connector from the CDB 410 or CDM 410.
3. Remove the CLV from the bracket.
Before doing so, mark the position and alignment on the bracket/station.
4. Install, align, and connect the replacement device.
5. Connect the PC to the host interface 2 (RS 232) of the CLV using a 3-core RS 232 data cable (null modem cable). (CDB 410 or CDM 410: connect the PC to the internal, 9-pin "Aux" plug). (See Chapter 5.5.5 *Connecting the PC to the host interface 2 (RS 232)*, Page 5-7.) **Temporarily disconnect any existing electrical data connection to the host!**
6. Switch on the power supply to the CDB 410 or CDM 410.
After the CLV has started, it emits a tone to indicate that the self-test was successful. After a short while, it outputs two consecutive tones to indicate that it has switched to Reading mode. The "Device Ready" LED lights up.
7. Switch on your PC and start Windows.
8. Start "CLV Setup".
If the communication parameters on the PC and CLV are identical, CLV Setup uploads the parameter set from the CLV and displays the values on the tabs.
If CLV Setup can not establish communication with the CLV, carry out the procedure described in Chapter 10.3.3 *Starting "CLV Setup"*, Page 10-8, *Troubleshooting*.
9. Open the archived parameter set as a configuration file "*.scl" in CLV Setup and download it to the CLV.
10. Confirm the dialog box by choosing the TEMPORARY storage option.
11. Check whether the CLV reads the bar codes correctly.
Correct the parameter settings if necessary.
12. Finally, download the tested parameter set to the CLV and save it with the PERMANENT storage option.
The parameter set is transferred permanently to the replacement device.
13. Save the modified parameter set as a new configuration file in CLV Setup.

Troubleshooting

If the software version on the replacement (new) device is older than the version on the old device (e.g. new device is from warehouse stock), the parameter set transferred may contain coded parameters or parameter values that cannot be interpreted by the older software. The new device, however, outputs an error message in CLV Setup for each of these parameters/parameter values when the parameter set is downloaded.

- Check whether all of the parameter settings used are necessary to configure the CLV for the current reading application. If necessary, replace the software version in the new device.

If the software version on the new device is more recent than that on the old one, the default settings in the imported parameter set will include parameters that were not contained in the old version.

- Upload the parameter set from CLV to CLV Setup and check whether the new parameters are relevant for configuring the CLV for the current reading application. If necessary, change the parameter values and download the parameter set to the CLV again. Save the new parameter set as a configuration file in CLV Setup.

See also Chapter 10.3.10 *Dealing with unknown parameters*, Page 10-14.

- Tip** If a parameter set is duplicated on other devices with the same application conditions, you may have to change the device number of the individual CLVs subsequently using the DEVICE CONFIGURATION tab for this parameter set so that it can be evaluated in the host and then downloaded the parameter set again.

10.10 Accessories

10.10.1 Installation accessories

Order no.	Description	Fig.
2 020 077	Small mounting bracket with installation accessories	Fig. 10-13, Page 10-38
2 020 078	Large mounting bracket with installation accessories	Fig. 10-14, Page 10-38

Table 10-5: Accessories: installation accessories

10.10.2 Connection modules

Part No.	Type	Description
1 023 813	CDB 410-001	Connection module for one CLV 41x, with 15-pin D-Sub HD device socket, terminal strips (signal distributors) for wiring the data and functional interfaces, internal 9-pin D Sub "Aux" plug, cable grips (dia. 4.5 to 10 mm (0.18 to 0.39 in)), polycarbonate housing, enclosure rating max. IP 65, operating temperature 0 to +40 °C (32 to 104 °F), operating voltage 6 to 30 V DC.
1 025 361	CDM 410-0001	Connection module for one CLV 41x, with 15-pin D-Sub HD device socket, terminal strips (signal distributors) for wiring the data and functional interfaces, internal 9-pin D Sub "Aux" plug, cable grips (dia. 4.5 to 10 mm (0.18 to 0.39 in)), polycarbonate housing, enclosure rating max. IP 65, operating temperature -35 ¹⁾ to +40 °C (-31 ¹⁾ to 104 °F, operating voltage 6 to 30 V DC, power consumption 0.5 W without CLV 41x.
2 029 468	CMP 400	Power Supply Module (Connection Module Power) as plug-in module for the CDM 410 Connection Module. Power supply for CLV 41x from an AC power line. Input 100 to 250 V AC/50 to 60 Hz, output 24 V DC, max. 10.8 W (short-circuit proof). Connection to the CDM 410 via ribbon cable. Operating temperature 0 to +40 °C (32 to 104 °F).

1) Without any mounting or electrical installation work, otherwise -20 °C (-4 °F)

Table 10-6: Accessories: Connection modules

10.10.3 Bus connection modules

Order no.	Type	Description
6 020 896	BMV 10-0111	Bus connection module for connection of max. two CLVs to Profibus DP ; for the CLV 41x each with a 15-pin D Sub HD device socket. With a 9-pin D Sub bus socket, terminal strips (signal distributors) for wiring the RS 232 data interface and the functional interfaces, two internal 9-pin D Sub "Service" plugs, cable grips, die-cast aluminum housing, enclosure rating max. IP 54 (enclosure rating max. IP 65 with a plug hood), operating voltage 20 to 30 V DC
6 020 893	BMH 10-0111	Bus module for connection of a CLV to Profibus DP ; with terminal screws, a 9-pin D-sub bus socket, no housing, for top-hat-rail installation, enclosure rating max. IP 20, operating voltage 10 to 30 V DC
6 021 190	BMV 10-0311	Bus connection module for connection of max. two CLVs to DeviceNet , terminal strips for bus connection, otherwise, as BMV 10-0111
6 021 188	BMH 10-0311	Bus module for connection of one CLV to DeviceNet , otherwise as BMH 10-0111
1 012 672	BMS 10-0113	Bus connection module for the connection of one CLV to Interbus-S ; for the CLV 41x with a 15-pin D Sub HD device socket, two 9-pin D Sub bus connections (in/out), terminal strips (signal distributors) for wiring the data and functional interfaces, internal 9-pin D Sub "Service" plug, integrated power supply 230 V AC 50 Hz/ 24 V DC, cable grips, polycarbonate housing, enclosure rating max. IP 54
1 012 680	BMS 10-0112	as BMS 10-0113, but with integrated 115 V AC 50 to 60 Hz/24 V DC power supply
6 025 757	BMV 10-0411	Bus connection module for the connection of max. two CLV 41x to Ethernet TCP/IP . Data transmission rate 10 MBit/s. For each CLV 41x with a 15-pin D Sub HD device socket. With a 8-pin RJ-45 bus socket, terminal strips (signal distributors) for wiring the RS 232 data interface and the functional interfaces, two internal 9-pin D Sub "Service" plugs, cable grips, die-cast aluminum housing, enclosure rating max. IP 54 (enclosure rating max. IP 65 with a plug hood), operating voltage 20 to 30 V DC

Table 10-7: Accessories: bus connection modules

CLV 41x bar code scanner

Order no.	Type	Description
6 025 756	BMH 10-0411	Bus module for connection of one CLV to Ethernet TCP/IP . Data transmission rate 10 MBit/s. With terminal screws, a 8-pin RJ-45 bus socket, no housing, for top-hat-rail installation, enclosure rating max. IP 20, operating voltage 10 to 30 V DC
6 007 655	–	Power cable for BMS 10, 3-wire, length 2 m (6.56 ft), with 3-pin connector (grounding) and one open end (stripped)

Table 10-7: Accessories: bus connection modules (contd.)

10.10.4 Programming adapter

Order no.	Description
7 034 552	Programming adapter with 15-pin D-Sub HD plug/socket, 9-pin D-Sub plug to connect the PC (RS 232), a switch to connect the host interface 2 of the CLV either to the host or to the PC, 3 LEDs to indicate the status of the switching outputs "Result 1" to "Result 3", a push button switch to trigger the reading pulse in the CLV via the "Sensor 1" switching input

Table 10-8: Accessories: Programming adapter

10.10.5 Cables and plug-in connections

Order no.	Description	Wires	Length	Connection
6 010 075	Extension cable for data and functional interfaces, \varnothing 6.5 mm (0.27 in), shielded, with 15-pin D Sub HD socket and plug	15	2 m (6.56 ft)	CLV 41x to CDB 410/ CDM 410
6 010 137	Connection cable for data and functional interfaces, \varnothing 6.5 mm (0.27 in), with 15-pin D Sub HD socket and one open end (stripped)	15	2 m (6.56 ft)	CLV 41x to non- SICK power pack
2 014 054	Data connection cable RS 232, \varnothing 5 mm (0.2 in), shielded, with two 9-pin D Sub sockets. SICK null modem cable (pin 2 (RxD) and pin 3 (TxD) crossed)	3	3 m (9.84 ft)	PC to CDB 410/ CDM 410
6 010 088	Data cable, \varnothing 6.6 mm (0.27 in), shielded, for connection cables up to 3 m (9.84 ft) long	15 x 0.09 mm ² (28 AWG)	Cut to size	free
6 007 508	Data cable, \varnothing 8.5 mm (0.33 in), twisted pair, shielded	2 x 2 x 0.23 mm ² (24 AWG)	Cut to size	SICK network (RS 485)
6 009 438	D Sub connector housing (metal) for 9-pin or 15-pin HD inserts			
6 007 335	D Sub connector insert, 9-pin socket connector			
6 010 019	D Sub connector insert, 15-pin HD socket connector			
6 010 020	D Sub connector insert, 15-pin HD pin connector			

Table 10-9: Accessories: cables and plug-in connections

10.10.6 Reading pulse generators

Order no.	Description
4 030 794	Polling reflector, white, for short distances up to 0.5 m (19.7 in) (included in scope of supply)
4 030 795	Polling reflector, blue, with removable protective film, for long distances 0.5 to 0.8 m (19.7 to 31.5 in) (included in scope of supply)
4 032 086	Polling reflector for CLV 41.2 (high density)

Table 10-10: Accessories: reading pulse generators (polling reflectors)



The SICK catalog "SENSICK Industrial Sensors" (order no. 8 006 530, English version) contains a large selection of photoelectric switches and photoelectric proximity switches as well as the associated accessories (brackets, connection cables)

10.10.7 Network controller

Order no.	Type	Description
On request	CLX 200	Network controller with LCD, membrane-sealed keyboard, integrated power pack and 9-pin D-Sub connections for network, host and terminal, enclosure rating max. IP 31

Table 10-11: Accessories: Network controller

10.11 Dimensional drawings of the accessories

10.11.1 Mounting bracket

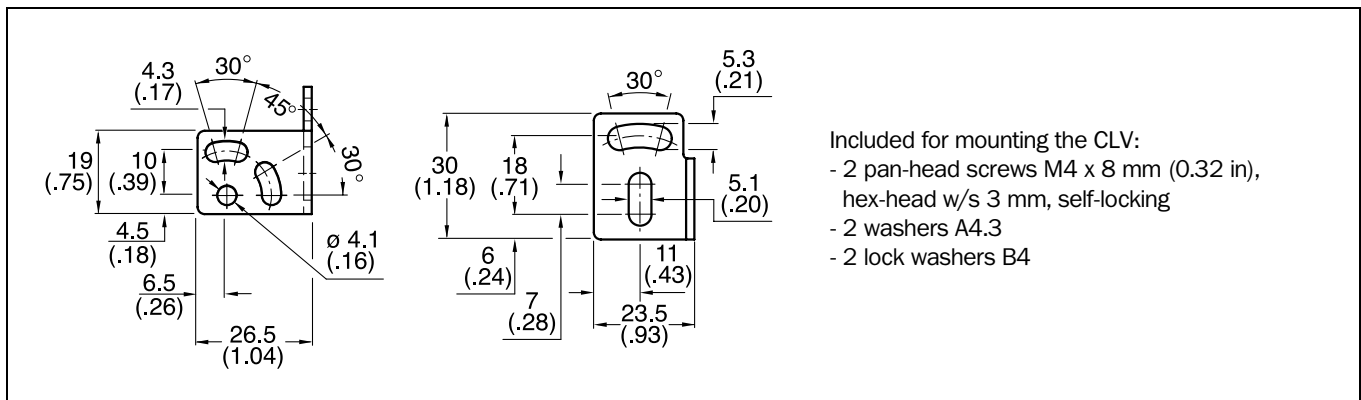

Fig. 10-13: Dimensions of the mounting bracket no. 2 020 077

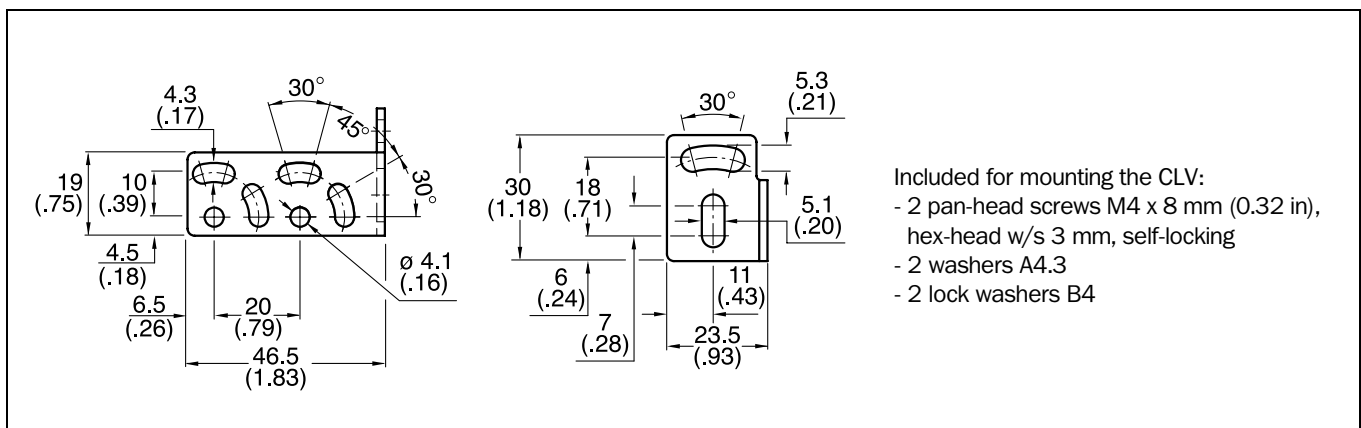

Fig. 10-14: Dimensions of the mounting bracket no. 2 020 078

10.12 Supplementary documentation

Part No.	Title	Language	Contents
8 010 000	"CDB 410 Connection Module" Operating Instructions	German/ English	Description for connecting the CLV to the host/PLC/sensor via the CDB 410 Connection Module
8 010 003	"CDM 410 Connection Module" Operating Instructions	German/ English	Description for connecting the CLV to the host/PLC/sensor via the CDM 410 Connection Module
8 010 365	"CMP 400 Power Supply Module" Operating Instructions	German/ English	Description for installing the module in the CDM 410 Connection Module
8 008 825	"BMV/BMH 10 for Profibus DP" operating instructions	English	Description for connecting the CLV to the Profibus/the PLC/the sensor via the bus connection module BMV/bus module BMH 10
8 008 972	"BMV/BMH 10 for DeviceNet" operating instructions		Description for connecting the CLV to the DeviceNet/the PLC/the sensor via the bus connection module BMV/bus module BMH 10
8 007 546	"BMS 10/20 for Interbus S" technical information	English	Description for connecting the CLV to the Interbus S/the PLC/the sensor via the bus connection module BMS 10/20
8 009 398	"BMV/BMH 10 for Ethernet" operating instructions	English	Description for connecting the CLV to the Ethernet/the PLC/the sensor via the bus connection module BMV/bus module BMH 10
8 007 675	"Master/Slave with CLV bar code scanners" Technical information	English	Description of the structure of a "daisy-chain configuration" (master/slave or data forwarding)
8 007 157	"Network Controller CLX 200" Technical Description	German/ English	Description of a SICK Network (RS 485) with CLV Bar Code Scanners
On request	Commando strings	English	Description of the CLV command strings

Table 10-12: Supplementary documentation (English versions)

10.12.1 CLV Connect (from Version 1.9)

Diagrams showing you how to connect the CDB 410 or CDM 410 Connection Module are also available in the "CLV Connect" PC program. This software is available on the "Manuals & Software" CD ROM, which is included in the scope of delivery of the CLV 41x.

The software can also be downloaded from the SICK home page (www.sick.de) at "Service&Support/Downloadpool".

It can be called up using a standard HTML browser (e. g. Internet Explorer™).

10.13 Glossary

For additional terms, see also *Online help – CLV Setup Help*.

Aperture angle α

Angle within whose limits the laser beam is deflected by the polygon mirror wheel.

A V-shaped range perpendicular to the scan direction, which must contain the bar code, is formed in front of the reading window. If only part of this aperture angle is used (part of the scan line symmetric around the center point), the depth of field for the focus position and resolution is greater.

Aspect ratio

Ratio of the code height (bar length) to the code length (number of characters).

AutoSetup

Function that allows the code and reading configuration of the CLV to be adapted automatically to the application at hand. The CLV searches for a bar code that is presented at a fixed distance and the optimum scan rate. It enters the code type and code length and disables all other code types and lengths.

CLV Assistant

The Assistant simplifies parameterization and testing of the CLV, among other things. It carries out configuration of the CLV for a user-specific reading situation with **one** bar code in simple steps. The determined settings are transferred to CLV Setup.

CLV Setup

PC program which runs under Windows 95™/98™, Windows NT4.0™, Windows 2000™ and Windows XP™. Used for offline parameterizing (adjustment to the reading application at hand) and the online operation of the CLV. The ⇨ parameter set is exchanged with the CLV by ⇨ uploading and ⇨ downloading it.

CLV Setup Help

Online help function that provides support for using the "CLV Setup" program. The help function contains explanations of the CLV parameters and their valid entries. Can be launched directly from CLV Setup in an HTML browser such as "Internet Explorer™".

Code geometry

Length and height dimensions of the bar code.

Code position (CP value)

Position of the first dark bar in a detected bar code along the ⇨ scan line. Calculated by the CLV for each scan and can be used, for example, to separate bar codes with identical data contents. The active evaluation range in the scan line can be restricted for ⇨ decoding purposes by specifying the maximum and minimum CP value for the application.

Command strings, commands

CLV user interface - alternative to the "CLV Setup" program. Basic, yet clearly structured command language for modifying the CLV parameter sets online. Accesses the CLV command interpreter directly. Special programming activities are required to use the command strings from the host.

Configuration file

File in the CLV Setup program that archives the entire ⇨ parameter set of the CLV. Can be printed out in the form of a table.

Data forwarding

Option of forwarding data sent by the host transparently to a terminal via the CLV using an identifier. Data can also be forwarded in the opposite direction. Furthermore, this function also allows data received on one of the serial interfaces to be output again straight away on one of the same interfaces (echo). Application: forwarding reading results or reading pulse commands in pass-through mode, e.g. in a master/slave network.

Data output string

Structured data telegram ⇨ in the reading result output by the CLV on the ⇨ host interfaces 1 and 2. The structure of the data string is flexible and can be adapted to a large extent to the subsequent data processing task.

Decoder, decoding

Code-type-specific evaluation routine for reconstructing the read bar code in electronic form in order to decode its data content.

Download

Method of transferring the ⇨ parameter set that was modified with the ⇨ CLV Setup program offline from the PC to the CLV. CLV Setup either always transfers a complete copy to the memory (RAM) of the CLV (DOWNLOAD TO CLV) or just the parameter previously processed using the context menu of the right mouse button (DOWNLOAD PARAMETER) or all parameters of the displayed tab (DOWNLOAD PARAMETERS OF THIS VIEW). You can overwrite the existing parameter set in EEPROM of the CLV by choosing the "Permanent" save option.

Error message

Detected device faults outputs the CLV by sending the error status ST= 3 via the host interface in reading mode. The CLV outputs further coded error messages (3 digits, 15xxx) only in the Self-test mode.

Error status

Identifier output with the reading result by the CLV for errors that were diagnosed while the bar code was being read. The entry for the host interface is made in the separator of the ⇨ data output string and must be enabled using the parameters (disabled by default in the CLV 41x).

Focus position

Distance of the focal point of the emitted laser beam in front of the reading window. Creates a distance-specific depth of field (DOF) in which the bar code can be recorded.

Functional interfaces

Switching inputs and outputs on the CLV.

Good Read

The CLV successfully detected a bar code or the required number of bar codes specified by the evaluation parameters during the ⇨ reading pulse.

Header

Data block in the reading result of the ⇨ host interface. Used as a header in the ⇨ data output string for the subsequent data content of the bar code. Contains up to 10 elements, consisting of reading diagnosis data and/or constants (control characters, letters, digits), depending on the configuration. The "Header" block is empty in the default setting of the CLV 41x.

Host Interface

Data interface on the CLV with configurable data output format. Used to output the ⇨ reading result in telegram form to the host/PLC. Integrates the CLV in the SICK network or builds a master/slave arrangement. The interface is also temporarily used to configure the CLV. The CLV provides two host interfaces which operate parallel (logical drivers of both interfaces active): host interface 1: RS 422/485, host interface 2: RS 232. It supports various transfer protocols.

Line scanner

Scanner that uses a polygon mirror wheel with paraxial mirrors to deflect a focused laser beam extremely fast. As a result, it creates a light spot in the reading plane that moves along a straight line, which appears to the naked eye as a stationary scan line.

Master/slave configuration

Special arrangement for connecting up to max. 7 CLVs in the SICK network to one reading station (e.g. left/right read). Thanks to the master, the entire network appears as one device to the host.

Multiple read

Variable number of reading operations that must provide identical reading results (data content) of the same bar code before the CLV outputs the result.

No Read

The CLV failed to detect a bar code or the required number of bar codes specified by the evaluation parameters during the ⇨ reading pulse.

No Read format

Special, parameterizable data block as a substitute for bar codes, which were expected but not detected, in the data output string on the host interface for ⇨ no reads. Comprises a variable combination of the error string and the ⇨ separator.

Parameter set

Data record used to initialize and activate the functions implemented in the CLV. With ⇨ downloading and ⇨ uploading, the parameter set is transferred from CLV Setup to the CLV or from the CLV to CLV Setup.

Percentage Evaluation

Special operating mode in which the quality of the reads (but not the bar codes) is assessed statistically. The bar codes must be stationary. The CLV carries out 100 scans and evaluates the reading quality. It then outputs the reading results on the ⇨ host interface every 2 s together with the ⇨ reading diagnosis data.

Profile bar code

Special bar codes that are created and printed using the ⇨ CLV Setup program. They contain coded parameters/parameter values from the parameter set. The profile bar codes can be used to configure the CLV with its optical interface (reading window) instead of a PC.

Raster height

Distance between the first and last of the eight parallel scan lines for the ⇨ raster scanner. The raster width is the distance between two adjacent scan lines.

Raster scanner

Scanner that uses a polygon mirror wheel with eight tilted mirrors to deflect its focused laser beam extremely quickly. As a result, it creates a light spot that moves quickly in eight rows across the reading plane.

Each light spot repeatedly moves along a straight line. It thereby appears to human eyes as one of eight stationary scan lines.

Reading area (DOF)

Depth of field around the focal point of the laser beam on two sides. The extent of the reading range depends on the resolution and reading distance.

Reading diagnosis data

Data directly derived from the reading procedure by the CLV. This data enables the quality of the read to be assessed. The data is always output on the ⇨ terminal interface together with the reading result. Only output on the host interface if enabled on the DATA STRINGS tab in the CLV Setup program (disabled by default for CLV 41x).

Reading field height

Length of the ⇨ scan line that is available for detecting the bar code in the reading plane. Due to the V-principle of beam generation, the reading field height is dependent on the reading distance.

Reading interval

Timeslot in which the CLV activates the laser diode and attempts to detect valid bar codes from the information read. The reading interval may be shorter than the external reading pulse, depending on the selected output mode for the reading result.

Reading pulse

Pulse applied externally to the CLV to trigger the internal ⇨ reading interval. Can be supplied by a photoelectric reflex switch or a command from the host on the serial interface.

Reading result

Electronic representation of the data content of the read bar code together with the ⇨ reading diagnosis data in one ⇨ data output string that is generated after the reading pulse has elapsed. The reading result on the host interface can be configured separately for good reads and no reads. Special characters can also be added if necessary.

Reflector polling

Reading pulse generated automatically by the CLV using a special bar code that serves as a reflector for the laser beam. The bar code is positioned opposite the CLV. The CLV polls

the reflector at regular intervals. When it is concealed by an object, the CLV starts the reading interval. It stops the reading interval once it detects the reflector again.

Result status output

Function of the "Result 1" to "Result 3" switching outputs and the beeper in Reading mode. Signals the status of the reading result without indicating its contents (e.g. Good Read). You can assign a status to each output on the DEVICE CONFIGURATION tab in the user interface of CLV Setup. The "Result" LED operates independent of the outputs and indicates only Good Read in the Reading mode (until the end of the next reading pulse).

Scan line

See line scanner.

Separator

Data block in the reading result of the \Rightarrow host interface. Used to add useful data to each bar code. Can be attached to the bar code as a prefix or suffix. Contains up to 10 elements, consisting of reading diagnosis data and/or constants (control characters, letters, digits). The "Separator" block is empty in the default setting of the CLV 41x.

Specification diagrams

Diagrams for reading the resolution-specific depth of field (DOF) for specific focus positions.

Storage in the CLV

The application-specific \Rightarrow parameter set can be stored temporarily or permanently in the CLV. If it is stored temporarily in the RAM, it is lost as soon as the power supply is switched off. Parameter sets that are stored permanently are transferred to the EEPROM in the CLV and remain active as the current data record when the power supply is switched off. The default setting is not affected by this and is stored in a read-only memory (ROM).

Teach-in

Method of programming the information required to adjust the CLV to the reading application in Parameter mode. Example: teaching-in match code 1 or teaching-in the application-specific bar code in \Rightarrow AutoSetup.

Terminator

Data block in the reading result of the \Rightarrow host interface. Used to terminate the data content of the bar code. Contains up to 10 elements, consisting of reading diagnosis data and/or constants (control characters, letters, digits). The "Terminator" block is empty in the default setting of the CLV 41x.

Transmission time

Point at which the reading result is output with respect to the start of the \Rightarrow reading pulse and the internal \Rightarrow reading interval.

Upload

Method of transferring the \Rightarrow parameter set from the CLV to the PC \Rightarrow using the CLV Setup program. CLV Setup either transfers a complete copy of the current parameter set from the memory (RAM) of the CLV (UPLOAD TO CLV) or just the parameter previously processed using the context menu of the right mouse button (UPLOAD PARAMETER) or all parameters of the

CLV 41x bar code scanner

displayed tab (UPLOAD PARAMETERS OF THIS VIEW). Displays the current parameter values on the tabs. Prerequisite for modifying the current parameter set.

User interface

Windows-based PC software "CLV Setup" for operating and configuring the CLV.

10.14 EC Declaration of Conformity

Fig. 10-15 shows the scaled down copy of the EC Declaration of Conformity (page 1).

- Complete copy of EC Declaration of Conformity on request.

SICK

EC Declaration of conformity

Ident-No. : 9048783 O639

The undersigned, representing the following manufacturer

SICK AG
 Nimburger Straße 11
 79276 Reute
 Deutschland

herewith declares that the product

CLV41.

is in conformity with the provisions of the following EC directive(s) (including all applicable amendments), and that the standards and/or technical specifications referenced in page 2 have been applied.

(place),...Reute..... (date),...*2004-07-05*.....

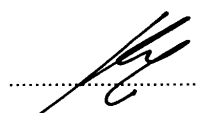

.....

ppa. Pierenkemper
(Manager Development
Division Auto Ident)



.....

ppa. Walter
(Manager Production
Division Auto Ident)

Fig. 10-15: Copy of the Declaration of Conformity, Page 1 (scaled down)

10.15 Index

Numerics

105° angle attachment
 - Dimensions.....9-3
 - View.....3-5

A

Abbreviations.....I-9
 Accessories
 - Dimensional drawings 10-38
 - Overview 10-36
 Adjustment4-7
 Aperture angle
 - Definition.....4-4
 - Max. value4-4
 AutoSetup
 - Activation with CLV Setup6-11
 - Activation with profile bar code.....10-16
 - Function6-11
 - Procedure.....6-11
 Azimuth angle (tilt)
 - Definition.....4-5
 - Limits.....4-5

B

Bar code
 - Calculating the code length.....10-25
 - Sample (scannable)11-50

Beeper

- Function3-8
 - Parameterization.....3-9
 - Position.....3-5

Browser

Browser.....3-2
 Bus connection modules
 - Ordering information10-36

C

Cables
 - Overview10-37
 - Wiring color assignment5-4
 Care.....7-1
 CD ROM.....3-1
 CDB 410/CDM 410 Connection modules
 - Block diagram.....5-1
 - Cables.....5-1
 - Function5-1
 - Installation.....4-8
 - Ordering information10-36
 - Types.....10-36
 Cleaning.....7-1
 CLV Assistant.....10-15

CLV Setup

- Default setting.....10-8
 - Download.....6-5
 - Functions (overview)10-12
 - Hot keys10-12
 - ini file.....10-15
 - Log file serial communication.....10-14
 - Start10-8
 - Tabs6-5
 - Unknown parameters.....10-14
 - Upload.....6-5
 - User interface.....10-11

CLV Setup Help

CLV Setup Help10-13
 Code position CP
 - Count direction in scan line.....4-6
 - Outputting in the data string.....4-6

Command strings

- Entry in terminal emulator10-22
 - Function.....10-22
 - Outputting in a file.....10-23

Configuration (parameterization)

Configuration (parameterization)6-4
 Connecting the PC.....5-7
 Connection diagram5-1
 Connector pin assignment.....5-2

D

Declaration of Conformity.....10-46
 Default settings
 - CLV extract.....6-2
 - CLV print out.....6-1
 - CLV Setup.....10-8

Depth of field (DOF)

Depth of field (DOF).....10-1

Device functions

- Perform in dialog box6-21

Device number GN

Device number GN5-3

DeviceNet

DeviceNet.....10-32

Dimensional drawings

Dimensional drawings.....9-3

Disposal

Disposal7-2

Documentation (supplementary)

Documentation (supplementary).....10-39

Download

Download
 - Execution6-5
 - Function.....6-4

E

Electrical installation

Electrical installation5-1

EMC

EMC9-2

Enclosure rating

Enclosure rating9-2

Error status messages

Error status messages3-6

Ethernet

Ethernet.....10-32

Evaluation

Evaluation
 - Parameterization6-9

F

FirmwareI-2

G

Glossary

Glossary10-40

Good read

Good read6-18

H

Header

Header.....6-16

Host interface		Operating	
- Connection	5-5	- Function of the LED	3-7
- Default setting	5-6	- With CLV Setup	6-14
- Function	3-6	- With command strings	10-22
- Hardware selection	5-3	Operating data	
- Max. cable lengths	5-3	- Display	6-19
- Parameterization	6-10	- Reset	6-20
I		Operating modes	
Inclination angle (pitch)		- AutoSetup	6-11
- Definition	4-5	- Overview	6-14
- Limits	4-5	- Percentage evaluation	6-17
Installation		- Profile programming	10-18
- Accessories	4-1	- Reading mode	6-14
- CLV	4-7	- Teach-in match code 1	10-26
- Overview	1-4	P	
- Preparations	4-1	Parameter set	
Interbus S	10-32	- Download	6-4
Interfaces of the CLV		- Function	6-4
- Functions	5-5	- Upload	6-4
- Overview	5-1	Parameterizing	
- Pin assignment	5-2	- Calculation of parameter values	10-16
L		- Function	6-4
Laser radiation		- Guide	6-7
- Laser power	2-2	- Replacing a CLV	10-33
- Laser warning label replacement	4-2	- With AutoSetup	6-11
- Laser warnings	2-2	- With CLV Setup	6-4
- Protection class	2-2	- With command strings	10-22
- Protective circuits	2-3	- With profile programming	10-16
- User information	2-2	Percentage evaluation	
- Wave length	2-2	- Activation	6-17
Laser timeout		- Behavior of "Result" LED	6-17
- Function	2-3	- Function	6-17
- Parameterization	6-9	- Output of reading result	6-17
LED indicators	3-7	Polling reflector	
- Function	3-7	- Function	4-8
- Position	3-5	- Installation	4-9
Line scanner		- Parameterize as pulse source	4-10
- Function	3-7	- Ranges	4-9
- Quick start	6-3	Power consumption	2-4
M		Power supply	5-3
Maintenance	7-1	- Connection	5-5
Malfunctions		Power-up delay	
- Diagnosis and rectification	8-3	- Function	5-3
- Error messages	8-2	- Parameterization	5-3
Master/slave	10-32	Product features	3-3
Method of operation of the CLV		Profibus DP	10-32
- Block diagram	3-6	Profile programming	
- Description	3-6	- Card no. 8 008 085	10-20
Mounting bracket		- Function	10-18
- Dimensions	10-38	- Printing profile bar codes	10-19
- Function	4-3	- Procedure	10-18
N		Programming adapter	10-37
No read	6-18	Protection class	9-2
O		Q	
Online help	10-13	Quick start	6-3

CLV 41x bar code scanner

R

Raster scanner
 - Function3-7

Reading distance
 - Definition.....4-4

Reading field diagrams10-2

Reading mode
 - Function6-14
 - Output of reading result.....6-14
 - Troubleshooting.....8-4

Reading pulse
 - Function3-6
 - Parameterization.....6-7
 - Trigger modes3-6
 - Troubleshooting.....8-4
 - Via terminal emulator.....6-16

Reading pulse sensor
 - Installation.....4-10
 - Parameterize as pulse source4-11
 - Switching input connection.....5-10

Reading result
 - Host interface6-14
 - Troubleshooting.....8-5

Reading window
 - Cleaning7-1
 - View3-5

Removal
 - Disposal7-2

Repairs8-8

Replacing a CLV
 - With CLV Setup10-34
 - With profile programming.....10-33

Result 1/Result 2/Result 3 switching outputs
 - Characteristic data.....5-12
 - Connection.....5-12
 - Function3-6
 - Parameterization.....6-10

Rotation angle (skew)
 - Definition.....4-5
 - Limits.....4-5

S

Safety
 - Authorized personnel.....2-1
 - Enclosure rating/protection class9-2
 - Features.....3-3
 - Intended use.....2-1
 - Laser radiation.....2-2
 - Notes on device3-1
 - Power supply.....5-3
 - Silicone2-4

Scope of delivery3-1

Securing threads
 - Dimensions.....4-3
 - Function4-3
 - Position.....3-5

Self-test

- Calling up.....6-20
 - Function.....6-20

Sensor 1/Sensor 2 switching inputs
 - Characteristic data5-10
 - Connection5-10
 - Function.....3-6
 - Parameterization6-7
 - Triggering teach-in match code 1.....10-26

Separation of bar codes
 - CP-value4-6
 - Parameterization6-9

Separator.....6-16

SICK Homepage1-1

SICK Network (RS 485)10-32

SICK Support.....8-8

Software versions.....1-2

Specification diagrams10-1

Startup6-3

Surface reflection
 - Prevention.....4-5

Switching off the CLV2-4

System requirements
 - Connection modules3-2
 - Power supply3-2
 - Sensors3-2

T

Table of figures.....1-11

Table of tables1-9

Teach-in match code 1
 - Code comparison activation.....10-26
 - Dynamic teach-in10-26
 - Function.....10-26
 - Static teach-in10-26

Technical data.....9-1

Terminal emulator6-14

Terminator6-16

Troubleshooting
 - Error messages in the reading result.....8-2
 - Troubleshooting.....8-3

U

UL Certification
 - Prerequisites.....1-2

Upload
 - Execution6-5
 - Function.....6-4

Use of the CLV.....2-1

User interface.....10-11

V

Variants3-1

View of device.....3-5

W

Warranty.....2-1

Windows.....3-2

10.16 Bar code samples

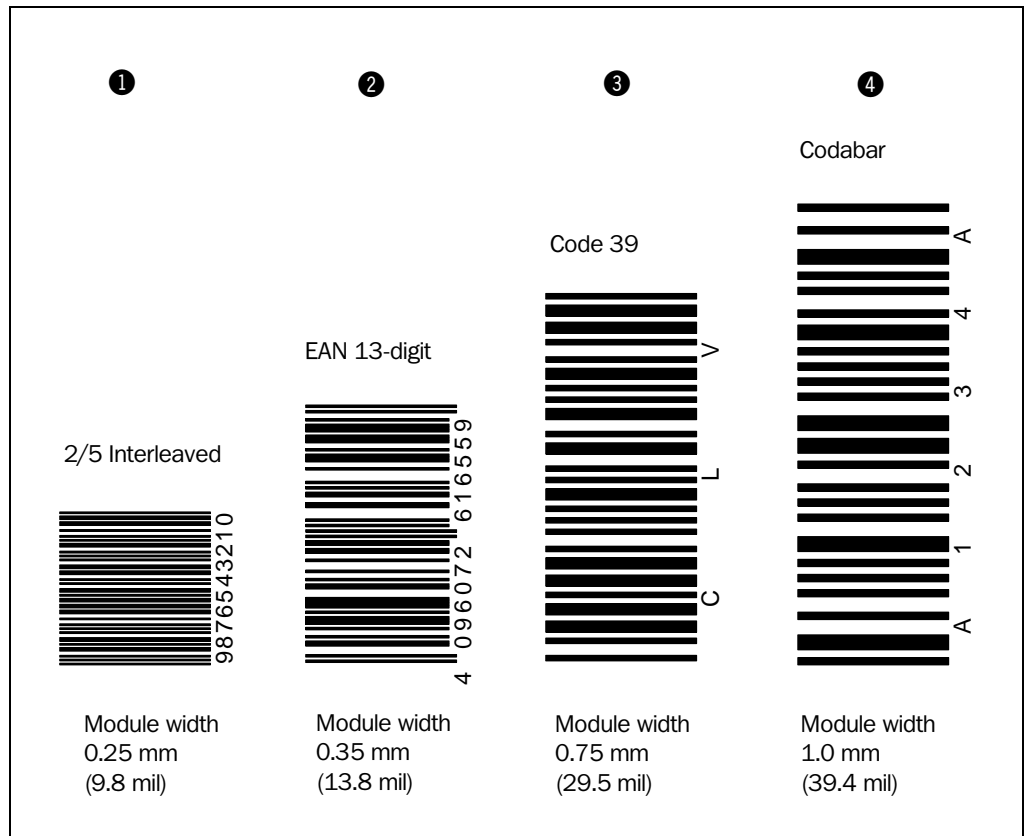

Fig. 10-16: Scannable bar codes with various module widths (print ratio 2:1)

Australia

Phone +61 3 9497 4100
1800 33 48 02 – tollfree
E-Mail sales@sick.com.au

Belgium/Luxembourg

Phone +32 (0)2 466 55 66
E-Mail info@sick.be

Brasil

Phone +55 11 5091-4900
E-Mail sac@sick.com.br

Ceská Republika

Phone +420 2 57 91 18 50
E-Mail sick@sick.cz

China

Phone +852-2763 6966
E-Mail ghk@sick.com.hk

Danmark

Phone +45 45 82 64 00
E-Mail sick@sick.dk

Deutschland

Phone +49 (0)2 11 53 01-270
E-Mail info@sick.de

España

Phone +34 93 480 31 00
E-Mail info@sick.es

France

Phone +33 1 64 62 35 00
E-Mail info@sick.fr

Great Britain

Phone +44 (0)1727 831121
E-Mail info@sick.co.uk

India

Phone +91-22-2822 7084
E-Mail info@sick-india.com

Italia

Phone +39 02 27 40 93 19
E-Mail info@sick.it

Japan

Phone +81 (0)3 3358 1341
E-Mail info@sick.jp

Nederlands

Phone +31 (0)30 229 25 44
E-Mail info@sick.nl

Norge

Phone +47 67 81 50 00
E-Mail austefjord@sick.no

Österreich

Phone +43 (0)22 36 62 28 8-0
E-Mail office@sick.at

Polska

Phone +48 22 837 40 50
E-Mail info@sick.pl

Republic of Korea

Phone +82-2 786 6321/4
E-Mail kang@sickkorea.net

Republika Slovenija

Phone +386 (0)1-47 69 990
E-Mail office@sick.si

Russia

Phone +7 95 775 05 30
E-Mail info@sick-automation.ru

Schweiz

Phone +41 41 619 29 39
E-Mail contact@sick.ch

Singapore

Phone +65 6744 3732
E-Mail admin@sicksgp.com.sg

Suomi

Phone +358-9-25 15 800
E-Mail sick@sick.fi

Sverige

Phone +46 8 680 64 50
E-Mail info@sick.se

Taiwan

Phone +886 2 2365-6292
E-Mail sickgrc@ms6.hinet.net

Türkiye

Phone +90 216 388 95 90 pbx
E-Mail info@sick.com.tr

USA/Canada/México

Phone +1(952) 941-6780
1 800-325-7425 – tollfree
E-Mail info@sickusa.com

More representatives and agencies
in all major industrial nations at
www.sick.com